



TENDER DOCUMENT
NEW MANGALORE PORT AUTHORITY
CIVIL ENGINEERING DEPARTMENT

NIT No. CIVIL/CE(C)/EE(C)/83/2024-25

E-Tender Event No 2025_NMPT_852770_1

Tender for

DEVELOPMENT OF GARDEN ADJACENT TO GODOWN NO:31 AND 32 AT
NMP

THROUGH E-TENDERING MODE

Tender Amount	:	Rs. 10,10,693/-
E.M.D.	:	Rs. 23,900/-
Tender Fee	:	Rs. 560/- (Including GST @ 12%)



TENDER DOCUMENT
NEW MANGALORE PORT AUTHORITY
CIVIL ENGINEERING DEPARTMENT

Tender for
“DEVELOPMENT OF GARDEN ADJACENT TO GODOWN NO:31 AND 32 AT
NMP”

Volume - 1

Table of Contents

i) NOTICE INVITING TENDER.....	9
ii) INSTRUCTIONS TO TENDERERS	12
A. Instructions for E-Tendering.....	12
B. Instructions To Tenderers (General).....	17
1. Introduction:.....	17
2. Applicants:	17
3. Invitation for Bids:	17
4. Purchase of Tender Documents:	17
5. One Bid per Bidder:	17
6. Cost of Bidding:.....	18
7. Site visit:	18
8. Content of Bidding Documents:	18
9. Clarification of the Bidding Documents:	19
10. Amendment of Bidding Documents:	19
11. Preparation of bids:.....	19
12. Minimum Eligibility Criteria:	19
13. Bid Prices:.....	21
14. Currencies of Bid and Payment:	21
15. Bid Validity:	21
16. Bid Security / EMD:	22
17. No Alternative Proposals by Bidders:.....	23
18. Format and Signing of Bid:	23
19. Bid Submission:	23
20. Deadline for Submission of the Bids:	25
21. Late Bids:	26
22. Modification and Withdrawal of Bids:	26
23. Bid Opening - Technical Bid:.....	26
24. Bid Opening – Financial Bid:.....	27
25. Clarification of Bids:	27

26.	Examination of Bids and Determination of Responsiveness:	27
27.	Correction of Errors: (Not Applicable).....	28
28.	Evaluation and Comparison of Bids:	28
29.	Alteration of tender documents:.....	28
30.	Alternative conditions and Proposal:	28
31.	Award of Contract:	29
32.	Notification of Award:	29
33.	Release of Bid Security / EMD:.....	29
34.	Performance Security:	30
35.	Fraud and Corrupt Practices:.....	30
36.	Rejection of Tender:	31
37.	Additional Information:	32
38.	Compliance of Local Content as per Make in India Policy:	32
	Annexure – 1.....	33
	Annexure – 2.....	34
	Annexure – 3.....	36
	Annexure – 4.....	37
	Annexure – 5.....	37
	Annexure – 6A (Not applicable)	40
	Annexure – 7.....	41
	Annexure – 8.....	42
	Annexure-9	44
	Annexure-10	46
	Annexure-11	47
	Annexure-12	48
	Annexure-13	50
	Annexure-14	51
	SECTION - II	53
	iii) FORM OF AGREEMENT	53
	SECTION - III.....	55
	iv) CONDITIONS OF CONTRACT.....	55
A.	General.....	55

1.	Definitions	55
2.	Interpretation.....	56
3.	Language and Law.....	57
4.	Engineer or his nominee’s Decisions.....	57
5.	Delegation	57
6.	Communications	57
7.	Contract Agreement.....	57
8.	Subcontracting	58
9.	Personnel.....	58
10.	Employer’s and Contractor’s Risks	58
11.	Employer’s Risks	59
12.	Contractor’s Risks	59
13.	Insurance	60
14.	Site Investigation Reports	60
15.	Queries about the Contract Data	60
16.	Contractor to Construct the Works.....	60
17.	The Works to Be Completed by the Intended Completion Date.....	60
18.	Approval by the Engineer or his nominee.....	61
19.	Safety.....	61
20.	Discoveries	61
21.	Possession of the Site.....	61
22.	Access to the Site.....	61
23.	Instructions.....	61
24.	Disputes.....	62
25.	Settlement of Disputes	62
26.	Replacement of Conciliator (Deleted)	63
B.	TIME CONTROL.....	64
27.	Program.....	64
28.	Revised Program.....	64
29.	Extension of the Intended Completion Date.....	64
30.	Delays Ordered by the Engineer or his nominee	65

31.	Management Meetings.....	65
32.	Early Warning.....	65
C.	QUALITY CONTROL.....	66
33.	Identify Defects.....	66
34.	Tests.....	66
35.	Defect Liability.....	66
36.	Uncorrected Defects.	67
D.	COST CONTROL	68
37.	Bill of Quantities.....	68
38.	Changes in the Quantities	68
39.	Variations.....	68
40.	Payments for Variations	69
41.	Cash flow forecasts.....	70
42.	Payment Certificates	70
43.	Payments.....	71
44.	Compensation Events.....	71
45.	Tax	72
46.	Currencies.....	73
47.	Price Adjustment. (Not Applicable).....	73
48.	Retention	78
49.	Liquidated Damages	78
50.	Nominated Subcontractors	79
51.	Advance payment (not applicable)	80
52.	Securities.....	80
53.	Removal of Craft or Plant which has sunk (not applicable to this contract).....	81
54.	Cost of Repairs	81
E.	FINISHING THE CONTRACT	82
55.	Completion.....	82
56.	Taking Over	82
57.	Final Account	82

58.	Submission of 'As built Drawings'	82
59.	Termination	82
60.	Payment upon Termination	84
61.	Property.....	84
62.	Release from Performance.....	84
F.	SPECIAL CONDITIONS OF CONTRACT	85
63.	Labour.....	85
64.	Compliance with labour regulations.....	85
65.	Safety, Security and Protection of the Environment.....	86
66.	Insurance of Works and Contractor's Equipment	86
67.	War Risks Insurance.....	88
68.	Royalty.....	88
69.	Transport of Contractor's Equipment or Temporary Works.....	88
70.	Transport of Materials or Plant	88
71.	Labor Laws & Regulations.....	89
72.	Life Saving Appliances and First Aid	92
73.	Diving Operations (Not Applicable).....	92
74.	Bribes.....	93
75.	Details to be Confidential	93
76.	Contractor's Temporary works, office, etc.....	93
77.	Water Supply.....	94
78.	Power Supply	94
79.	Taxes and Duties.....	95
80.	Price Adjustment (not applicable to this contract)	95
81.	Noise and Disturbance.....	96
82.	Safety Code	96
83.	Port Authority Rules.....	97
84.	Execution of work	97
85.	Customs Duty	98
86.	Drawings & Designs (Not applicable to this contract)	100
87.	Monsoon Period.....	101

88.	Progress Report.....	101
89.	Completion Documents	102
90.	Facilities / Services to be provided at the site (Not Applicable)	102
91.	Payments.....	103
92.	Retention	104
93.	Submission of statutory documents.....	104
v)	CONTRACT DATA	107
	Price Adjustment (deleted)	109
vi)	FORM OF SECURITIES	111
	Annexure A.....	112

NEW MANGALORE PORT AUTHORITY

PANAMBUR, MANGALORE -575010

NIT No: CIVIL/CE(C)/EE(C)/83/2024-25 Date: 11-03-2025

TENDER ID: 2025_NMPT_852770_1

i) NOTICE INVITING TENDER

(Through E-Procurement only)

E-Tenders are invited by New Mangalore Port Authority, Panambur, Mangalore-575010 through <https://www.eprocure.gov.in/eprocure/app> of CPP portal from the reputed Contractor fulfilling the Minimum Eligibility Criteria stipulated in this notice in two cover bidding procedure for the work of "Development of Garden adjacent to Godown No:31 and 32 at NMP

Minimum Eligibility Criteria:

- a) The tenderers must have experience of having successfully or substantially completed *similar works during last 7 (seven) years ending last day of month previous to the one in which applications are invited shall be either of the following

At least Three similar completed works costing not less than the amount equal to Rs. 4.05 Lakhs each (excluding GST)

or

At least Two similar completed works costing not less than the amount equal to Rs. 5.06 Lakhs each (excluding GST)

or

At least One similar completed works costing not less than the amount equal to Rs. 8.09 Lakhs (excluding GST)

Note 1: *Similar work(s) means "Horticulture works"

Note 2: Documentary evidence for successful completion of the work shall be furnished along with work order and work completion certificate.

Note 3: Substantial completion shall be based on 80 (eighty) per cent (value wise) or more works completed under the contract. Certificate for 'substantial completion' of project/work/asset should contain two parts. Part -I shall contain 'financial value of work done' and part-II shall contain 'certificate of functional completion of project/work/asset'.

- b) Average Financial turnover of the tenderer over the last three financial years 2021-22, 2022-23 and 2023-24 shall be at least Rs.3.04 Lakhs.

The financial capacity of bidders would be evaluated considering the works in hand at NMPA on the due date of submission of bid. The port would deduct the turnover required for execution of work in hand at NMPA from the average financial turnover of the bidder. The remaining net financial turnover of the bidder will be considered for eligibility criteria. The financial capacity to be

3.33 times of the average financial turnover of last three years of the bidder minus works in hand at NMPA. The bidder must fill the annexure-6.

- c) The tenderer shall submit a copy of valid ESIC & EPF registration certificate along with the tender.

Pertinent information is given in the following table:

i)	Estimated Amount put to Tender	Rs 10,10,693/- (excluding GST)
ii)	Earnest Money Deposit (EMD)	Rs. 23,900/- (Rupees TwentyThree Thousand Nine Hundred Only.) The EMD shall be paid by RTGS in favour of F.A. & C.A.O., NMPA. Scanned copy should be uploaded along with bid. The benefit of Exemption of EMD to all Micro and small enterprises (MSE) will allowed. Shall upload with their offer, the proof of their being MSE registered with district industries center (DIC) or Khadhi and village industries commission or Khadhi and Industries board (KVIV) or Coir board or National Small Industries Corporation (NSIC) or Directorate of handicrafts and handlooms or Udyam Registration Certificate or any other body specified by Ministry of MSME.
iii)	Cost of Tender (Tender fee)	Rs. 560/- (Rupees Five Hundred Sixty Only) Payment of Tender fee by NEFT in favour of F.A. & C.A.O., NMPA. Scanned copy should be uploaded along with bid. Scanned copy should be uploaded along with bid. The benefit of Exemption of Tender Fees to all Micro and small enterprises (MSE) registered with district industries center (DIC) or Khadhi and village industries commission or Khadhi and Industries board (KVIV) or Coir board or National Small Industries Corporation (NSIC) or Directorate of handicrafts and handlooms or any other body specified by Ministry of MSME, will be considered.
iv)	Document download start date and time	11-03-2025 at 15.00 HRS
v)	Seek clarification start date and time	11-03-2025 at 15.00 HRS
vi)	Seek clarification end date and time	17-03-2025 at 15.00 HRS

vii)	Bid submission start date and time	25-03-2025 at 10.00 HRS
vii)	Bid submission closing date and time	01-04-2025 at 15.00 HRS
ix)	Date & time of opening of Cover -I : Technical Part - II : Financial	02-04-2025 at 15.30 HRS Shall be communicated separately.
x)	Completion period	1 (One) Month including monsoon
xi)	Validity of Tender	90 days from the date of closing of online submission of e-tender.

Tenderer shall have to pay the prescribed cost of tender i.e., Rs. 560/- (Rupees Five Hundred Sixty Only) by NEFT in favour of F.A. & C.A.O., NMPA.

NMPA Bank Details.

1. Name of the Bank: State Bank of India, Panambur, Mangalore - 575 010.
2. Bank A/C No. 10205649448
3. IFSC Code: SBIN0002249
4. MICR Code: 575002011

Contact Nos. 0824-2887306 / 2887308 and 0824- 2407493

Email id: bhagyalaxmi.b@nmpt.gov.in and chiefengineer@nmpt.gov.in Amendments / further information etc. pertaining to the tender, if any shall be uploaded only on websites <https://www.eprocure.gov.in/eprocure/app> of CPP portal, may have to be referred by the prospective Tenderer from time to time.

-sd-

Executive Engineer (Civil)

NEW MANGALORE PORT AUTHORITY

PANAMBUR, MANGALORE -575010

NIT No: CIVIL/CE(C)/EE(C)/83/2024-25

E-Tender event No. 2025_NMPT_852770_1

ii) INSTRUCTIONS TO TENDERERS

A. Instructions for E-Tendering

INSTRUCTION TO E-TENDERING

1. SPECIAL INSTRUCTIONS TO THE BIDDERS FOR THE E-SUBMISSION OF THE BIDS ONLINE THROUGH THIS E-PROCUREMENT PORTAL

This is an e-procurement event of NMPA. The e-procurement service provider is <https://www.eprocure.gov.in/eprocure/app> of CPP portal. You are requested to read the terms & conditions of this tender before submitting your online tender. Tenderers who do not comply with the conditions with documentary proof (wherever required) will not qualify in the Tender.

1. Bidder should do Online Enrolment in the Portal using the option Click Here to Enroll available in the Home Page. Then the Digital Signature enrollment has to be done with the e-token, after logging into the portal.
2. Bidder then logs into the portal giving user id / password chosen during enrollment.
3. The e-token that is registered should be used by the bidder and should not be misused by others.
4. DSC once mapped to an account cannot be remapped to any other account. It can only be inactivated.
5. The Bidders can update well in advance, the documents such as certificates, purchase order details etc., under My Documents option and these can be selected as per tender requirements and then attached along with bid documents during bid submission. This will ensure lesser upload of bid documents.
6. After downloading / getting the tender schedules, the Bidder should go through them carefully and then submit the documents as per the tender document; otherwise, the bid will be rejected.
7. The BOQ template must not be modified/replaced by the bidder and the same should be uploaded after filling the relevant columns, else the bidder is liable to be rejected for that tender. Bidders are allowed to enter the Bidder Name and Values only.
8. If there are any clarifications, this may be obtained online through the e-Procurement Portal, or through the contact details given in the tender document. Bidder should take into account of the corrigendum published before submitting the bids online on the portal or on

www.newmangaloreport.gov.in Bidder, in advance, should prepare the bid documents to be submitted as indicated in the tender schedule and they should be in PDF formats.

9. Bidder should arrange for the EMD and tender fee as specified in the tender. The benefit of Exemption of EMD and Tender Fees to all Micro and small enterprises (MSE) registered with district industries center (DIC) or Khadhi and village industries commission or Khadhi and Industries board (KVIV) or Coir board or National Small Industries Corporation (NSIC) or Directorate of handicrafts and handlooms or Udyam Registration Certificate or any other body specified by Ministry of MSME, will be considered. Necessary document should be submitted along with Technical Bid. The bidders who avail exemption from payment of EMD, shall submit "Bid Security Declaration" in the prescribed format as per Annexure 14, accepting that if they withdraw or modify their bids during period of validity etc., they will be suspended for the time specified in the tender document.
10. The bidder should read the terms and conditions and accepts the same to proceed further to submit the bids.
11. The bidder has to submit the tender document(s) online well in advance before the prescribed time to avoid any delay or problem during the bid submission process.
12. There is no limit on the size of the file uploaded at the server end. However, the upload is decided on the Memory available at the Client System as well as the Network bandwidth available at the client side at that point of time. In order to reduce the file size, bidders are suggested to scan the documents in 75-100 DPI so that the clarity is maintained and the size of file gets reduced. This will help in quick uploading even at very low bandwidth speeds.
13. It is important to note that, the bidder has to click on the Freeze Bid Button, to ensure that, he/she completes the Bid Submission Process. Bids, which are not frozen, are considered as Incomplete/Invalid bids and are not considered for evaluation purposes.
14. The Tender Inviting Authority (TIA) will not be held responsible for any sort of delay or the difficulties faced during the submission of bids online by the bidders due to local issues.
15. The bidder may submit the bid documents online mode only, through this portal. Offline documents will not be handled through this system.
16. At the time of freezing the bid, the e-Procurement system will give a successful bid updating message after uploading all the bid documents submitted and then a bid summary will be shown with the bid no., date & time of submission of the bid with all other relevant details. The

documents submitted by the bidders will be digitally signed using the e-token of the bidder and then submitted.

17. After the bid submission, the bid summary has to be printed and kept as an acknowledgement as a token of the submission of the bid. The bid summary will act as a proof of bid submission for a tender floated and will also act as an entry point to participate in the bid opening event.
18. Successful bid submission from the system means, the bids as uploaded by the bidder is received and stored in the system. System does not certify for its correctness.
19. The bidder should see that the bid documents submitted should be free from virus and if the documents could not be opened, due to virus, during tender opening, the bid is liable to be rejected.
20. The time that is displayed from the server clock at the top of the tender Portal, will be valid for all actions of requesting bid submission, bid opening etc., in the e-Procurement portal. The Time followed in this portal is as per Indian Standard Time (IST) which is GMT+5:30. The bidders should adhere to this time during bid submission.
21. The bidders are requested to submit the bids through online e-Procurement system to the Tender Inviting Authority (TIA) well before the bid submission end date and time (as per Server System Clock).
22. Tender form Fee and EMD shall be submitted with the Part I- Technical BID. BID submitted without fees, as mentioned above will not be considered for evaluation and shall be rejected summarily. The benefit of Exemption of EMD to all **Micro** and small enterprises (MSE) will be considered. The bidders shall upload with their offer, the proof of their being MSE registered with district industries center (DIC) or Khadhi and village industries commission or Khadhi and Industries board (KVIV) or Coir board or National Small Industries Corporation (NSIC) or Directorate of handicrafts and handlooms or Udyam Registration Certificate or any other body specified by Ministry of MSME. The bidders who avail exemption from payment of EMD, shall submit "Bid Security Declaration" in the prescribed format as per Annexure 14, accepting that if they withdraw or modify their bids during period of validity etc., they will be suspended for the time specified in the tender document.
23. The bidder/tenderer/contractor shall file the applicable returns with Tax departments in time and submit the same as documentary proof.
24. The bidder/tenderer/contractor shall file the applicable returns with Tax departments in time and submit the same as documentary proof.

25. The GST applicable shall be shown as a separate line items in the Tax invoices to avail in put credit to Port.

2. Cover – I Details (Technical)

The following documents shall be uploaded online only.

1. Scanned copy of NEFT Payment details for cost of tender or exemption certificate
2. Scanned copy of RTGS/NEFT Payment details for EMD (bid security) / documentary evidence for exemption of EMD. The original document to be submitted by post or by hand immediately after the closing date for submission of online e-tender)
3. Scanned copy of documents as per Annexure 1 to 13 of section I(iii) of volume-I. The Original power of attorney i.e. Annexure 2 to be submitted by post or by hand immediately after the closing date for submission of online e-tender. However, such Power of Attorney would not be required if the bid is signed by an authorized partner or Director (on the Board of Directors) of the bidder, in case the bidder is a partnership firm or limited liability partnership or public limited.
4. Scanned copy of valid Pan card, PF, ESI and GST Registration certificate.
5. List of Ongoing works in hand at NMPA should be indicated in the prescribed form
6. Scanned copy of Form of Tender as per Section VI(iii) of volume -III
7. Technical bid document – Cover I (Volume I to Volume III) along with amendments and clarifications if any.

3. Cover – II Detail (Finance)

PRICE BID (Bill Of Quantities)

Price should be quoted in the BOQ template available in the portal. The BOQ template must not be modified/replaced by the bidder and the same should be uploaded after filling the relevant columns, else the bidder is liable to be rejected for that tender. The Bidder shall fill in the rate for each items in the Bill of Quantities through CPP e-portal. Bidders are allowed to enter the Bidder Name and Values only.

Any indication of 'Quoted price' in the online technical bid documents shall lead to rejection of the bid outright.

The price bid submitted through e-portal mode only will be taken up for the purpose for evaluation.

4. Opening of bids

- A. Part I Techno-Commercial bid will be opened electronically on specified date and time as given in the NIT. Bidder(s) can witness electronic opening of bid.

B. Part II Price bid will be opened electronically of only those bidder(s) whose Part I Techno-Commercial Bid is found to be Techno-Commercially acceptable by NMPA. Such bidder(s) will be intimated, the date of opening of Part II Price bid, through valid email confirmed by them.

Note: The tenderers are advised to offer their best possible rates. There would generally be no negotiations hence most competitive prices may be quoted while submitting the price bid. However in case the lowest rate appears to be reasonable taking into account the prevailing market conditions, the work may be awarded to the lowest bidder and if the rate is still considered high, action as per prevailing instructions / guidelines shall be taken. All entries in the tender should be entered in online Technical & Commercial Formats without any ambiguity.

5. Evaluation process:

A proposal shall be considered responsive if –

- a. It is received by the proposed Due Date and Time.
- b. It is signed.
- c. It contains the information and documents as required in the Tender Document.
- d. It contains information in formats specified in the Tender Document.
- e. It mentions the validity period as set out in the document.
- f. It provides the information in reasonable detail. The Port Authority reserves the right to determine whether the information has been provided in reasonable detail.
- g. There are no significant inconsistencies between the proposal and the supporting documents.
- h. The Technical qualification conforms to as specified in the qualification criteria.
- i. A Tender that is substantially responsive is one that conforms to the preceding requirements without material deviation or reservation. A material deviation or reservation is one (1) which affects in any substantial way, the scope, quality, or performance of the Tenderer or (2) which limits in any substantial way, inconsistent with the Tender document, or (3) whose rectification would affect unfairly the competitive position of other Qualified Applicant presenting substantially responsive bids.
- j. The Port Authority reserves the right to reject any tender which in its opinion is non-responsive and no request for alteration, modification, substitution or withdrawal shall be entertained by the Port Authority in respect of such Tenders.
- k. The Port Authority would have the right to review the Technical

Qualification and seek clarifications wherever necessary.

1. Since the tender involves selection based on pre-qualification criteria and technical specification, the Chief Engineer will examine and seek clarification if any and list out the firms, which are found technically suitable and Cover-II Price Bid of such tenderers only will be opened and EMD will be returned to the unsuccessful tenderers
- m. The date and time will be intimated to tenderers whose offers are found suitable and Cover – II of such tenderers will be opened on the specified date and time
- n. The cost of stamping Agreement must be borne by the successful Tenderer
- o. The Fax/E-Mail offers will be treated as defective, invalid and rejected. Only detailed complete offers received through online prior to closing time and date of the tenders will be taken as valid.

B. Instructions To Tenderers (General)

1. Introduction:

This work essentially comprises of “Development of Garden adjacent to Godown No:31 and 32 at NMP”

2. Applicants:

Contractors who wish to bid for the tender for the contract work should download the tender document. The successful bidder will be expected to complete the works by the intended completion date specified in the Contract document.

3. Invitation for Bids:

The online Invitation for Bids is open to all eligible bidders meeting the eligibility criteria. The bidders may submit bids for the works detailed in the NIT through e-tender mode only.

4. Purchase of Tender Documents:

Tender document can be downloaded from NMPA website www.newmangaloreport.gov.in, www.tender.gov.in & <https://www.eprocure.gov.in/eprocure/app> of CPP portal

5. One Bid per Bidder:

Each bidder shall submit only one bid for one package. Bidder who submits or participates in more than one Bid will cause all the proposals with the Bidder’s participation to be disqualified.

6. Cost of Bidding:

The bidder shall bear all costs associated with the preparation and submission of his Bid, and the Employer will in no case be responsible and liable for those costs.

7. Site visit:

The Bidder, at the Bidder's own responsibility and risk is encouraged to visit and examine the work site and its surroundings and obtain all information that may be necessary for preparing the Bid and entering into a contract for construction of the Works. The costs of visiting the site shall be at the Bidders' own expense.

8. Content of Bidding Documents:

Tender Document will consist of:

Volume I	Section I	Notice Inviting Tenders Instructions to Tenderers Annexure (1 to 13)
	Section II	Form of Agreement
	Section III	Conditions of Contract: Part A - E: General Conditions Conditions of Contract : Part F: Special Conditions Contract Data Form of Securities (A & B) Appendix - I and Appendix - II
Volume II	Section IV	Technical Specifications
	Section V	Drawings
Volume III	Section VI	Preamble Bill of Quantities For of tender
	Section VII	Schedules (A & B)

Any indication of "Quoted price" in the technical bid, shall lead to rejection of the bid outright. For evaluation purpose the uploaded offer documents will be treated as authentic and final. No hard copy shall be submitted, upload the entire document on the CPP portal only.

9. Clarification of the Bidding Documents:

The Tenderers are advised to examine the Tender Document carefully and if there be or appear to be any ambiguity or discrepancy in the documents, or any clarifications needed on the Tender Documents; these shall be referred to the Chief Engineer (Civil) in writing, so as to reach before seek clarification end date and time. It is to be noted that queries asked after due date and time will not be answered. Employer's clarifications shall be furnished in the CPP e-portal or shall be issued a corrigendum in the web site without identifying the source.

A provision is made in the CPP e-portal for seeking clarification online during the date mentioned in the NIT. The bidders can ask queries if any during the period through online. The queries of the bidders shall be answered online or a separate consolidated list of queries and clarifications shall be uploaded in web sites.

10. Amendment of Bidding Documents:

Any modification of the tender documents as a result of any ambiguity shall be shall be made exclusively through the issue of an Addendum. Any addendum thus issued shall be part of the tender documents and will be uploaded in CPP e-portal and Port website to all the bidders. Prospective bidders shall acknowledge receipt of each addendum to the Employer. Such addenda will be numbered and it shall be submitted by the Tenderers as part of Part I of their bid. The Addendum can also be downloaded from NMPA official website from 'Ongoing Project link'. The responsibility of downloading such addendum / amendment from NMPA website and CPP e-portal fully lies with the bidder

11. Preparation of bids:

All documents relating to the bid shall be in the English language.

12. Minimum Eligibility Criteria:

- a) The tenderers must have experience of having successfully or substantially completed *similar works during last 7 (seven) years ending last day of month previous to the one in which applications are invited shall be either of the following

At least Three similar completed works costing not less than the amount equal to Rs. 4.05 Lakhs each (excluding GST)

or

At least Two similar completed works costing not less than the amount equal to Rs. 5.06 Lakhs each (excluding GST)

or

At least One similar completed works costing not less than the amount equal to Rs. 8.09 Lakhs (excluding GST)

Note 1: *Similar work(s) means **“Horticulture works”**

Note 2: Documentary evidence for successful completion of the work shall be furnished along with work order and work completion certificate.

Note 3: Substantial completion shall be based on 80 (eighty) per cent (value wise) or more works completed under the contract. Certificate for ‘substantial completion’ of project/work/asset should contain two parts. Part -I shall contain ‘financial value of work done’ and part-II shall contain ‘certificate of functional completion of project/work/asset’.

- b) Average Financial turnover of the tenderer over the last three financial years 2021-22, 2022-23 and 2023-24 shall be at least Rs.3.04 Lakhs.
- c) The tenderer shall submit a copy of valid ESIC & EPF registration certificate along with the tender.

The financial capacity of bidders would be evaluated considering the works in hand at NMPA on the due date of submission of bid. The bidder would deduct the turnover required for execution of work in hand at NMPA from the average financial turnover of the bidder. The remaining net financial turnover of the bidder will be considered for eligibility criteria. The financial capacity to be 3.33 times of the average financial turnover of last three years of the bidder minus works in hand at NMPA. The bidder must fill the annexure-6.

In case the average turnover is Rs. 3.00crores, the financial capacity of the contractor will be considered as (3x3.333) Rs.10.00crores.

The turnover means sales/ contract receipts excluding taxes other income shall not be considered for calculation of turnover

Copy of the work order, Client’s satisfactory work completion Certificate, along with any other documentary proof certifying the date of completion, brief description of the project and project completion cost shall be submitted in support of the assignments performed and claimed by the tenderer to fulfill the eligibility criteria for qualification. Work completion certificate issued by a private organization shall be considered, only if Tax Deducted at Source Certificate with respect to referred work, issued by Competent Authority is enclosed along with the tender. In case work executed on subcontract, only approved or authorized subcontract shall be considered for eligible assignment.

A statement duly certified by the Chartered accountant showing the average annual Financial Turnover over the last 3 financial years duly indicating UDIN shall be submitted.

Even though the bidders meet the above qualifying criteria, they are subject to be disqualified if they have:

- i. made misleading or false representations in the forms, statements, affidavits and attachments submitted in proof of the qualification requirements; and/ or;
- ii. Records of poor performance during the last five years, as on the date of application, such as abandoning the work, rescission of the contract for reasons which are attributable to non-performance of the contractor, inordinate delays in completion, consistent history of litigation resulting in awards against the contractor or any of the constituents, or financial failure due to bankruptcy, and so on. The rescission of a contract of venture JV on account of reasons other than nonperformance, such as the most experienced partner (major partner) of JV pulling out;
- iii. On account of currency of debarment by any Government agency.

13. Bid Prices:

The contract shall be for the whole works as described in based on the priced Bill of Quantities submitted through CPP e-portal by the Bidder .The Bidder shall fill rate in the Bill of Quantities through CPP e-portal. Items for which no rate or price is entered will not be paid for by the Employer when executed and shall be deemed covered by the other rates and prices in the Bill of Quantities

14. Currencies of Bid and Payment:

The Unit rates and the prices shall be quoted by the bidder entirely in Indian Rupees

15. Bid Validity:

Bids shall remain valid for a period not less than ninety days (90 days) after the last date for online bid submission. A bid valid for a shorter period shall be rejected by the Employer as non-responsive.

In exceptional circumstances, prior to expiry of the original bid validity period, the Employer may request that the bidders may extend the period of validity for a specified additional period. The request and the bidders' responses shall be made in writing or by cable. A bidder agreeing to the request will not be permitted to modify his bid and also shall submit an extension for EMD, if it

is in the form of Bank Guarantee

16. Bid Security / EMD:

i. The EMD shall be paid by RTGS/NEFT in favour of Financial Adviser & Chief Accounts Officer, New Mangalore Port Authority, Mangalore NMPA Bank Details.

1. Name of the Bank: State Bank of India, Panambur, Mangalore - 10.
2. Bank A/C No. 10205649448
3. IFSC Code: SBIN0002249
4. MICR Code: 575002011.

The Techno Commercial Bid shall be accompanied by the RTGS/NEFT deposit details towards Earnest Money Deposit of Rs. 23900/- (Rupees TwentyThree Thousand Nine Hundred Only) as stipulated in the tender. The tender without EMD shall be treated invalid.

- ii. The benefit of Exemption of EMD to all Micro and small enterprises (MSE) will allowed. Shall upload with their offer, the proof of their being MSE registered with district industries center (DIC) or Khadhi and village industries commission or Khadhi and Industries board (KVIV) or Coir board or National Small Industries Corporation (NSIC) or Directorate of handicrafts and handlooms or Udyam Registration Certificate or any other body specified by Ministry of MSME.
- iii. The bidders who avail exemption from payment of EMD, shall submit "Bid Security Declaration" in the prescribed form as per Annexure 14, accepting that if they withdraw or modify their bids during period of validity etc., they will be suspended for the time specified in the tender document.
- iv. In the event of Bidder withdrawing his Bid before the expiry of tender validity period of 90 days from the last date for online bid submission, the tender shall be cancelled and EMD shall be forfeited.
- v. The Earnest Money Deposit of unsuccessful bidder shall be returned without interest on conclusion of contract. The Earnest Money Deposit of the successful bidder shall be refunded (without interest) after he has signed the agreement and furnished required performance security.
- vi. The Bid Security of a successful bidder will be forfeited in the following cases:
- a) If the bidder withdraws his Tender during the period of bid validity.
 - b) In case of a successful tenderer fails
 - i) to commence the work, apart forfeiture of other claims
 - ii) within the specified time limit to sign the Agreement or furnish the required Performance Security. In the event of forfeiting the EMD / SD / LD and while imposing penalty GST as applicable will be

collected.

17.No Alternative Proposals by Bidders:

Bidders shall submit offers that comply with the requirements of the bidding documents, including the basic technical design as indicated in the drawing and specifications. Alternatives will not be considered.

18.Format and Signing of Bid:

The Bid shall be in online mode. The Bid shall contain no alterations or additions, except those comply with instructions issued by the Employer

19.Bid Submission:

Tender document including quoted bid price have to be submitted online only through CPP Portal before deadline for online submission of bid.

For evaluation purpose the uploaded offer documents will be treated as authentic and final.

The Tender shall be submitted in Two Bids.

I. Technical Bid: Shall contain the following.

- i) Techno Commercial Bid: Shall contain all the documents. Techno Commercial Bid should not contain Price Bid. "Disclosure/indication of Price in the Techno Commercial Bid shall render the tender disqualified and rejected.
- ii) The details of payment of EARNEST MONEY DEPOSIT for Rs. 23900/- (Rupees TwentyThree Thousand Nine Hundred Only)
- iii) Transaction details of payment towards the COST OF TENDER Fee: Rs. 560/-(Rupees Five Hundred Sixty Only) (To be paid by RTGS/NEFT to NMPA Bank Account).
- iv) List of Ongoing works in hand at NMPA should be indicated in the prescribed form.

II. FINANCIAL BID: shall contain only the Price. The Bidder shall fill the excess or less in percentage in the Bill of Quantities

III. LAST DATE FOR SUBMISSION OF ONLINE TENDER: is as per the date mentioned in the NIT

NMPA may at its sole discretion reserves the right to extend the date for receipt of Bid. Bid after the aforesaid time and date or the extended time and date, if any, shall not be accepted by the portal.

The following details pertaining to Techno Commercial Bid shall be uploaded online.

- a) Letter of Submission- Covering letter (vide Annexure – 1)
- b) Power of Attorney in favour of signatory/s to the Tender, duly

authenticated public notary only in the prescribed form as per Annexure - 2) (Original power of attorney ie. Annexure 2 to be submitted by post or by hand so as to reach the Executive Engineer (Civil) immediately after the closing date for submission of online e-tender). However, such Power of Attorney would not be required if the bid is signed by an authorized partner or Director (on the Board of Directors) of the bidder, in case the bidder is a partnership firm or limited liability partnership or public limited.

- c) Organization Details (vide Annexure-3)
- d) Details of “Minimum eligibility criteria” as per Clause 12 of instruction to Tenderers and certificates (Client Certificates / work completion certificates or any other documentary evidences with respect to the eligibility work) (vide Annexure-4) of condition of contract. The following specific instruction may be noted ;
 - i) Bidders are expected to provide information in respect of Eligible Assignments in this Section. The assignments cited must comply with the criteria specified in Clause No. 12 (a) for “Minimum eligibility”.
 - ii) A separate sheet should be filled for each of the eligible assignments.
 - iii) the details are to be supplemented by documentary proof from the respective client for having carried out such assignment duly certified by client’s completion certificates and work orders etc.
- e) A statement duly certified by Chartered Accountant with UDIN showing Average Financial turnover of the tenderer over the last three financial years (vide Annexure-5) with balance sheet.
- f) List of Ongoing works in hand at NMPA should be indicated in the prescribed form (Annexure 6).
- g) A list of Plant and equipment proposed to be engaged for work. (vide Annexure-7) The equipment indicated in the Annexure -7 will form part of contract agreement and as such the bidders are requested to indicate the availability of the equipment at site at what stage of the construction period the equipment would made available.
- h) A declaration to the effect that (vide Annexure -8):-
 - a. All details regarding construction plant and machinery, temporary work and personnel for site organization considered necessary and sufficient for the work have been furnished in the Annexure to Conditions of Contract in Volume I and that such plant, temporary works and personnel for site organization will be available at appropriate time of relevant works for which the

equipment have been proposed at site till the completion of the respective work.

- b. No conditions are incorporated in the financial bid. In case any conditions are specified in the financial bid, the tender will be rejected summarily without making any further reference to the bidder.
- c. We have not made any payment or illegal gratification to any persons/ authority connected with the bid process so as to influence the bid process and have not committed any offence under PC Act in connection with the bid.
- d. We disclose with that we have made / not made payments or propose to be made to any intermediaries (agents) etc in connection with the bid.
- e. We have not been barred by the [Central/ State] Government, or any entity controlled by it, from participating in any project and the bar subsist as on the due date of Tender.
- i) NEFT Payment details towards cost of tender.
- j) RTGS/NEFT Payment details towards EMD / documentary evidence of exemption of EMD.
- k) Tenderer should submit copy of Permanent Account Number. (PAN), ESI, PF and GST Registration (GSTIN) Number along with certificates issued by the authority as applicable

20. Deadline for Submission of the Bids:

- i) The completed bid shall be submitted in the electronic form by the date and time mentioned in NIT only through CPP e-portal.
- ii) The Employer may extend the deadline for submission of bids by issuing an amendment in accordance with Clause 10, in which case all rights and obligations of the Employer and the bidders previously subject to the original deadline will thereafter be subject to the deadline as extended.
- iii) Price should be quoted in CPP e-portal. Any indication of 'Quoted price' in the online technical bid documents shall lead to rejection of the bid outright. For evaluation purpose the uploaded offer documents will be treated as authentic and final. No hard copy shall be submitted for reference purpose. The bid submitted through e-tendering mode only will be taken up for the purpose for evaluation.
- iv) The uploaded Port Tender Document will be treated as authentic tender and if any discrepancy is noticed at any stage between the Port's tender document and the one submitted/uploaded by the tenderer, the conditions mentioned in the Port's uploaded document shall prevail. Besides, the

tenderer shall be liable for legal action for the lapses.

21. Late Bids:

The tenderer should ensure that their tender is received online at NMPA before the deadline prescribed in Clause 20

The time that is displayed from the server clock at the top of the CPP e-portal, will be valid for all actions of requesting bid submission, bid opening etc., The bidders should adhere to this time during bid submission.

22. Modification and Withdrawal of Bids:

- i) Bidders may modify the offers by deleting their already freezed bids in online only through CPP e-portal (after submission of bid) and resubmit/upload the revised offer before the deadline prescribed in Clause 20.
- ii) No bid shall be withdrawn and resubmitted through CPP e-portal by the bidder after the deadline for submission of bids.
- iii) Withdrawal of a Bid between the deadline for submission of bids and the expiration of the original period of bid validity specified in Clause 15 may result in the forfeiture of the Bid Security pursuant to Clause 16.
- iv) Bidders may only modify the prices and other required details of their Bids by Resubmitting Bid only in accordance with this clause through CPP e-portal.

23. Bid Opening - Technical Bid:

- a. On the due date and time as specified in Clause 20, the Employer will On the due date and time as specified in Clause 20, the Employer will first open Techno Commercial bids of all bids received online in presence of the Bidders or their representatives who choose to attend. In the event of specified date for bid opening is declared as holiday by the Employer, the bid will be opened at the appointed time and location on the next working day.
- b. In the first instance the Techno Commercial Bid containing the RTGS/NEFT payment details of EMD & Cost of tender document will be verified. If EMD and Tender Fee is in line with the Tender Condition there after the Techno Commercial Bid will be considered for evaluation. The benefit of Exemption of EMD to all Micro and small enterprises (MSE) will allowed. Shall upload with their offer, the proof of their being MSE registered with district industries center (DIC) or Khadhi and village industries commission or Khadhi and Industries board (KVIV) or Coir board or National Small Industries Corporation (NSIC) or Directorate of

handicrafts and handlooms or Udyam Registration Certificate or any other body specified by Ministry of MSME.

- c. If all Bidders have submitted unconditional Bids together with requisite Bid security, then all Bidders will be so informed then and there. If any Bid contains any deviation from the Bids documents and / or if the same does not contains Bid security in the manner prescribed in the Bid documents, then that Bid will be rejected and the Bidder informed accordingly.

24. Bid Opening – Financial Bid:

The date and time of opening of price bid (cover-II) shall be intimated to the qualified bidders based on the evaluation of the technical bid. The price bid (cover-II) of such eligible bidders shall be opened on the specified date and time.

If bidder withdraws his tender after opening of price bid the bidder will be disqualified for participating in NMPA tender for a period of two years.

25. Clarification of Bids:

To assist in the examination and comparison of Bids, the Employer may, at his discretion, ask any Bidder for clarification of his Bid, including breakdown of unit rates. The request for clarification and the response shall be in writing, but no change in the price or substance of the Bid shall be sought, offered, or permitted.

No Bidder shall contact the Employer on any matter relating to his bid from the time of the bid opening to the time the contract is awarded. If the Bidder wishes to bring additional information to the notice of the Employer, he should do so in writing.

Any effort by the Bidder to influence the Employer's bid evaluation, bid comparison or contract award decisions, may result in the rejection of his bid. Employer reserves the right to reject any Bid, if the Bidder does not provide the clarification sought for by the Employer, within the time specified by the Employer, for proper evaluation of the Bid.

The employer may proceed to evaluate the bid by construing the particulars requiring clarification to the best of its understanding, and the bidder shall be barred from subsequently questioning such interpretation of the employer.

26. Examination of Bids and Determination of Responsiveness:

Prior to detailed evaluation of Bids, NMPA will determine whether each Bid

- a) has been properly signed by an authorised signatory (accredited representative) holding Power of Attorney in his favour only in the prescribed form as per Annexure 2. The Power of Attorney shall interalia

- include a provision to bind the Bidder to settlement of disputes clause;
- b) is accompanied by the requisite Bid security and;
- c) meets the eligibility criteria as defined in Clause 12.
- d) is responsive to the requirements of the Bidding documents.

A responsive Bid is one which conforms to all the terms, conditions and specification of the Bidding documents, without material deviation or reservation. A material deviation or reservation is one

- i. which affects in any substantial way the scope, quality or performance of the Works;
- ii. which limits in any substantial way, the Employer's rights or the Bidder's obligations under the Contract; or
- iii. whose rectification would affect unfairly the competitive position of other Bidders presenting responsive Bids.

The tenderer shall submit a certificate in the tender schedule in the Technical Bid that he has not incorporated any conditions in the Financial Bid and in case any conditions are specified in the financial bid his tender will be rejected without making any further reference to him.

If a Bid is not substantially responsive, it shall be rejected by the Employer, and may not subsequently be made responsive by correction or withdrawal of the non-conforming deviation or reservation.

27. Correction of Errors: (Not Applicable)

28. Evaluation and Comparison of Bids:

The Employer will evaluate and compare only the Bids determined to be responsive in accordance with Clause 26. In evaluating the Bids, the Employer will determine for each Bid the evaluated Bid Price by adjusting the Bid Price as follows:

- a) making appropriate adjustments to reflect discounts or other price modifications offered in accordance with Clause 22.

29. Alteration of tender documents:

No alteration shall be made in any of the tender documents or in the Bill of Quantities and the tender shall comply strictly with the terms and conditions of the tender document. The Employer may however ask any tenderer for clarifications of his tender if required. Nevertheless, no tenderer will be permitted to alter his tender price after opening of the tender.

30. Alternative conditions and Proposal:

The Tenderer shall note that alternative or qualifying tender conditions, or

alternative design proposal for whole or part of the work will not be acceptable. Tenders containing any qualifying conditions or even Bidder's clarifications in any form will be treated as non-responsive and will run the risk of rejection. Part II: Price Bid of such Bidder's will not be opened.

31. Award of Contract:

The Employer will award the Contract to the bidder whose bid has been determined to be responsive to the bidding documents and who has offered the lowest evaluated bid price, provided that such bidder has been determined to be

- a) Eligible in accordance with the provisions of Clause 12, and
- b) Qualified in accordance with the provisions of Clause 12.

32. Notification of Award:

- i) The Bidder whose Bid has been accepted will be notified about the award by the Employer prior to expiration of the Bid validity period by, fax or e-mail and confirmed by registered letter. This letter (hereinafter and in the Conditions of Contract called the "Letter of Acceptance") will state the sum that the Employer will pay the Contractor in consideration of the execution, completion and maintenance of the works by the Contractor as prescribed by the Contract (hereinafter and in the Contract called the "Contract Price").
- ii) The notification of award will constitute the formation of the Contract subject only to the furnishing of a performance security in accordance with the provisions of Clause 33.
- iii) The Agreement will also incorporate all correspondence exchanged between the employer and the successful bidder. Within 21 days of receipt of Letter of Acceptance, the successful bidder will furnish the performance security and sign the Agreement with the Employer. The contractor shall make 10 copies of the Agreement and submit to the employer within 7 days following the date of signing of Agreement. The work shall not be commenced without signing contract agreement.

33. Release of Bid Security / EMD:

The Earnest Money Deposit of unsuccessful bidder shall be returned (in case of BG) or refunded without interest by RTGS/NEFT on conclusion of Contract. The Earnest Money Deposit of the successful bidder shall be refunded (without interest) after he has signed the agreement and furnished required performance security.

34. Performance Security:

- i) Within 21 days of receipt of the Letter of Acceptance, the successful Bidder shall deliver to the Employer a Performance Security remitted by RTGS or Bank Guarantee (BG) for an amount equivalent to 5% of the Contract price (Contract price including GST), as applicable rounded off to the nearest 1000.
- ii) If the performance security is provided by the successful Bidder in the form of a Bank Guarantee, it shall be issued by a Nationalized /Scheduled Indian bank having its branch at Mangalore acceptable by NMPA and cashable at Mangalore. The BG shall be issued in favor of FA&CAO, New Mangalore Port Authority in the Format enclosed in Volume I as Annexure-A.
- iii) The Contractors are shall furnish the BG by the issuing bank directly to the Port through SFMS mode with ICICI Bank IFSC Code ICIC0000014. This will not near any interest. Bank Guarantee, obtained from the Nationalized bank / Scheduled bank in the format prescribed shall be in complaine with for a digital confirmation for the Bank guarantee and the BG not complying with this shall not be considered.

35. Fraud and Corrupt Practices:

The bidder and their respective officers, employees, agents and advisers shall observe the highest standard of ethics during the Selection Process. Notwithstanding anything to the contrary contained in this document, the Port shall reject the tender without being liable in any manner whatsoever to the bidder, if it determines that the bidder has, directly or indirectly or through an agent, engaged in corrupt practice, fraudulent practice, coercive practice, undesirable practice or restrictive practice (collectively the "Prohibited Practices") in the Selection Process. In such an event, the Port shall, without prejudice to its any other rights or remedies, forfeit and appropriate the Bid Security or Performance Security, as the case may be, as mutually agreed genuine pre-estimated compensation and damages payable to the Port for, inter alia, time, cost and effort of the Authority, in regard to the Tender, including consideration and evaluation of such Bidder's Proposal. Such Bidder shall not be eligible to participate in any tender or RFP issued by the Authority during a period of 2 (two) years from the date such Bidder is found by the Authority to have directly or through an agent, engaged or indulged in any corrupt practice, fraudulent practice, coercive practice, undesirable

practice or restrictive practice, as the case may be.

For the purposes of this Clause, the following terms shall have the meaning hereinafter respectively assigned to them:

- (a) “corrupt practice” means
 - i) the offering, giving, receiving, or soliciting, directly or indirectly, of anything of value to influence the action of any person connected with the Selection Process (for avoidance of doubt, offering of employment to or employing or engaging in any manner whatsoever, directly or indirectly, any official of the Authority who is or has been associated in any manner, directly or indirectly with the Selection Process or the LOA or has dealt with matters concerning the Agreement or arising there from, before or after the execution thereof, at any time prior to the expiry of one year from the date such official resigns or retires from or otherwise ceases to be in the service of the Authority, shall be deemed to constitute influencing the actions of a person connected with the Selection Process; or
 - ii) engaging in any manner whatsoever, whether during the Selection Process or after the issue of the LOA or after the execution of the Agreement, as the case may be, any person in respect of any matter relating to the Project or the LOA or the Agreement, who at any time has been or is a legal, financial or technical consultant/ adviser of the Authority in relation to any matter concerning the Project;
- (b) “fraudulent practice” means a misrepresentation or omission of facts or disclosure of incomplete facts, in order to influence the Selection Process;
- (c) “coercive practice” means impairing or harming or threatening to impair or harm, directly or indirectly, any persons or property to influence any person’s participation or action in the Selection Process;
- (d) “undesirable practice” means
 - i) establishing contact with any person connected with or employed or engaged by the Authority with the objective of canvassing, lobbying or in any manner influencing or attempting to influence the Selection Process; or
 - ii) having a Conflict of Interest; and
- (e) “restrictive practice” means forming a cartel or arriving at any understanding or arrangement among Applicants with the objective of restricting or manipulating a full and fair competition in the Selection Process.

36. Rejection of Tender:

Any Tender not conforming to the foregoing instructions will not be

considered. The Employer does not bind himself to accept the lowest or any tender and has the right to reject any tender without assigning any reason thereof. No representation whatsoever will be entertained on this account.

37. Additional Information:

The "Instructions to Tenderers" shall not form part of the Contract. They are intended only to aid the Tenderers in the preparation of their tender.

38. Compliance of Local Content as per Make in India Policy:

Bidder shall comply with DPIIT Order No. P-45021/2/2017-PP(B-II) dtd. 16-09-2020 in respect of Local Content and furnish an undertaking in the prescribed format as per Annexure 13, to that effect, failing which, the bid may be liable for cancellation.

Annexure - 1

LETTER OF SUBMISSION - COVERING LETTER
(ON THE LETTER HEAD OF THE BIDDER)

Date:

To

The Executive Engineer (Civil),
New Mangalore Port Authority,
Administration Building,
Panambur, Mangalore – 575 010

Sir,

Sub: The work of “Development of Garden adjacent to Godown No:31 and 32 at NMP Being duly authorized to represent and act on behalf of (Hereinafter referred to as “the Bidder”) and having reviewed and fully understood all of the requirements of the bid document and information provided, the undersigned hereby apply for the project referred above.

We are submitting our Bid enclosing the following, with the details as per the requirements of the Bid Document, for your evaluation.

- i. Tender Document along with Addendum No ----,
- ii. Power of Attorney - (Annexure - 2)
- iii. Organization Details - (Annexure - 3)
- iv. Details to fulfill the “Minimum Eligibility Criteria” and certificates - (Annexure 4)
- v. Average Financial turnover over the last three financial year - (Annexure 5)
- vi. List of ongoing works at New Mangalore Port Authority (Annexure 6)
- vii. List of plant and equipment – (Annexure - 7)
- viii. Declaration – (Annexure – 8)
- ix. Bid Security / EMD Paid by RTGS/NEFT vide UTR No.....dtd. of (name and address of the branch).
- x. Banker’s Details – Annexure 10 & 11
- xi. Tender fee paid by NEFT vide vide UTR No.....dtd. of (name and address of the branch).
- xii. Copy of valid ESI, PF & GST Registration certificate.

Signature
(Authorised Signatory)

Annexure – 2

ON STAMP PAPER of Rs 100/-
 “DEVELOPMENT OF GARDEN ADJACENT TO GODOWN NO:31 AND 32 AT
 NMP--

FORMAT OF POWER OF ATTORNEY (in original)

In favour of signatory/s to the Tender, duly authenticated by Notary Public.

POWER OF ATTORNEY IN FAVOUR OF -----
 (Name, Designation, Company name)

TO ALL TO WHOM THESE PRESENTS shall come, I, (Name & address of the authorized person to sub-delegate/delegate powers, delegated on him by the Board of Directors) do hereby sub-delegate/delegate, in terms of the powers delegated to me by the Board of Directors, ----- (name of the Co.) to Shri ----- (name, designation & address of the Attorney) the following:

NOW KNOW YE AND THOSE PRESENTS that I, (Name & address of the authorized person to sub-delegate/delegate powers, delegated on him by the Board of Directors), do hereby authorize and empower Shri ----- (name, designation & address of the Attorney) to do severally amongst others, for the purpose of carrying on our business, the following:

- a) To represent lawfully the (name of the Co.) for obtaining bid/tender documents, prepare, sign, execute and submit tenders for execution of (Name of work) or any other works incidental to such construction works.
- b) To discuss the technical and financial matters, negotiate and accept prices and take decisions regarding terms and conditions and sign agreements and contracts and also to bind the (name of the Co.) to the arbitration clause included in the contract.
- c) For all or any of the purposes here of to sign and deliver or otherwise execute such deed or deeds, transfer or transfers, endorsement or endorsements and to perform such other acts, matters, things as the Attorney shall consider requisite or advisable as full and effectively as the Company could do, if present and acting there.

I, (Name & address of the authorized person to sub-delegate/delegate powers, delegated on him by the Board of Directors) in terms of the powers delegated to me by the Board of Directors of (name of the Co.), do hereby agree that all acts, deeds and things done by the said Attorney by virtue of this power of attorney, shall be construed as acts, deeds and things done by the Company.

I, (Name & address of the authorized person to sub-delegate/delegate powers,

delegated on him by the Board of Directors), further undertake to ratify and confirm whatever our said attorney shall do or cause to be done for the Company, the said Company, in the premises, by virtue of the powers hereby given.

WHEREAS, this sub-delegation is signed and delivered to Shri ----- (name & designation of the Attorney), on this _____ day of _____, 20____ (Two thousand _____).

WHEREAS, even though this sub-delegation is signed on this _____ day of _____ 20____ (Two thousand _____), will have effect from the date he signs and receives this delegation.

IN WITNESS WHEREOF, I, (Name & address of the authorized person to sub-delegate/delegate powers, delegated on him by the Board of Directors) has, this _____ day of _____ 20____ (Two thousand _____) set my hands and subscribed my signature unto this instrument.

SIGNED AND DELIVERED ON

_____ BY

(Name of authorized person to delegate powers)

WITNESS:

SIGNED AND RECEIVED ON

_____ BY

(Name & designation of Attorney)

Annexure – 3

“DEVELOPMENT OF GARDEN ADJACENT TO GODOWN NO:31 AND 32 AT
NMP--

ORGANIZATION DETAILS

CONTACT No.:

NAME OF APPLICANT:

1. Name of the Owner:
2. Address:
Telephone No. :
Fax No.
3. Description of Applicant
(for e.g. General, Civil Engineering
Contract or Joint Venture/Consortium etc.)
4. Registration and Classification of Contractors:
5. Name and address of bankers:
6. Number of years of experience as a general contractor:-
In own Country:
Internationally:
7. Number of years of experience as a sub-contractor:
Name and Address of partners or associated companies to be involved in the
project and whether Parent/Subsidiary/other:
8. Name and address of any associates knowledgeable in the procedures of
customs, immigration and local experience in various aspect of the project etc.
9. Name and address of the companies / Sub-contractors who will be involved
in the execution of works, namely:

Signature
(Authorised Signatory)

Annexure – 4

NEW MANGALORE PORT AUTHORITY
 “DEVELOPMENT OF GARDEN ADJACENT TO GODOWN NO:31 AND 32 AT
 NMPTenderer shall furnish Details of “eligibility works experience” as per
 Clause 12(a) of Minimum Eligible Criteria (MEC) of Instruction to Tenderer
 and certificates in the following format (Client Certificates/work completion
 certificates or any other documentary evidences with respect to the eligibility
 work)

ELIGIBLE ASSIGNMENT DETAILS FOR MEC

Assignment Number:

Sl. No.	Description	Bidder to fill up the details here
1	Name and Address of the Client	
2	Title of the Eligible Assignment	
3	Date of completion of the Eligible Assignment	
4	Project Cost	
5	Reference No of the enclosed work order	
6	Reference No of the enclosed Client work Completion Certificate	
7	Reference No of any other documentary evidence; if enclosed.	
8	Name, telephone no, telefax no and email address of the client’s representative	
9	Description and Scope of Work	

Signature

(Authorised Signatory)

Certificate from the Statutory Auditor

This is to certify that the information contained in Column 4 above is correct as per the accounts of the Applicant and/ or the clients.

(Signature, name and designation of the authorised signatory)

Date: Name and seal of the audit firm:

In case the Applicant does not have a statutory auditor, it shall provide the certificate from its chartered accountant that ordinarily audits the annual accounts of the Applicant.

Instructions:

- i. Bidders are expected to provide information in respect of Eligible Assignments in this Section. The assignments cited must comply with the criteria specified Clause No. 12.0(a) Minimum eligibility of the “Instructions to Tenderers”.
- ii. A separate sheet should be filled for each of the eligible assignments.
- iii. The details are to be supplemented by documentary proof (Work order and work completion certificate) from the respective client for having carried out such assignment duly certified by clients.

Annexure – 5

NEW MANGALORE PORT AUTHORITY

“DEVELOPMENT OF GARDEN ADJACENT TO GODOWN NO:31 AND 32 AT
NMPFINANCIAL CAPABILITY

(A) Net worth & Average Annual Turnover of the Bidder

Net Worth	Turnover				
	Year 1 2023-24	Year 1 2023-24	Year 2 2022-23	Year 3 2021-22	Average

Instructions:

Net Worth = (Subscribed and Paid-up Equity + Reserves) - (Revaluation reserves + Miscellaneous expenditure not written off + depreciation not provided for). Year 1 will be the Financial Year 2023-24. Year 2 shall be the year immediately preceding Year 1 and Year 3 shall be the year immediately preceding Year 2. The Bidder shall provide audited Annual Reports as required under this Bid Document.

Net worth & Annual turnover of the bidder shall be submitted duly verified by Chartered Accountant or Competent Authority.

(B) (Here specify proposed sources of credit line to meet the Cash flow demand for the work)

Source of Credit line	Amount

There should be a letter from the Bank mentioning that line of credit offered is specifically for this work/contract.

NOTE: If the Tenderer intends to meet the “Cash Flow Demand” for the project through their internal resources without availing the loan of credit, a specific mention to be made to this effect and proof for such resources shall be enclosed.

Certified by C.A
(Authorised Signatory)

Signature

UDIN :

Annexure – 6

NEW MANGALORE PORT AUTHORITY
““DEVELOPMENT OF GARDEN ADJACENT TO GODOWN NO:31 AND 32 AT
NMP

LIST OF ONGOING WORKS IN HAND AT NEW MANGALORE PORT

The Tenderer shall furnish in the format given below details of works being carried out by him at the time of bidding in New Mangalore Port

Sl.No.	Name of work	Work order No. and Date	Value of Work Order in Rs.	Average annual financial turnover as per MEC for the work

Contractor

Annexure – 6A (Not applicable)

NEW MANGALORE PORT AUTHORITY

“DEVELOPMENT OF GARDEN ADJACENT TO GODOWN NO:31 AND 32 AT
NMP

DETAILS OF PROPOSED APPROACH & METHODOLOGY

Bidder shall furnish a detailed method statement (Technical Note) for carrying out of the works, along with a construction programme showing sequence of operation and the time frame for various segments of temporary and permanent works.

Signature

(Authorised Signatory)

Annexure - 7

NEW MANGALORE PORT AUTHORITY
 “DEVELOPMENT OF GARDEN ADJACENT TO GODOWN NO:31 AND 32 AT
 NMP--

PLANT AND EQUIPMENT PROPOSED FOR THE WORK

Please indicate the main plant and equipment considered to be necessary for undertaking the work and whether this plant is ready in ownership or will be purchased or hired.

Description of equipment	Requirement no. / capacity	Owned / leased / to be procured	Nos / capacity	Age / condition	Remarks (from whom to be purchased)	At what stage of contract period the equipment will be available

Note: The equipment indicated in the above statement will form part of contract agreement and as such the bidders are requested to indicate the availability of the equipment at site and at what stage of the construction period in a separate column.

Signature
(Authorised Signatory)

Annexure – 8

NEW MANGALORE PORT AUTHORITY
“DEVELOPMENT OF GARDEN ADJACENT TO GODOWN NO:31 AND 32 AT
NMP
DECLARATION

We M/s. (Name & address of the bidder) hereby declare that:-

- i. I have read the tender document Vol. I (Section I to III) Vol.II (Section IV and V) and Vol.III (Section V and VII) and agreed to the terms and conditions mentioned therein.
- ii. All details regarding construction plant, temporary work and personnel for site organisation considered necessary and sufficient for the work have been furnished in the Annexures to Conditions of Contract in Volume I and that such plant, temporary works and personnel for site organisation will be available at the site till the completion of the respective work.
- iii. No conditions are incorporated in the financial bid. In case any conditions are specified in the financial bid, the tender will be rejected summarily without making any further reference to the bidder.
- iv. We have not made any payment or illegal gratification to any persons/ authority connected with the bid process so as to influence the bid process and have not committed any offence under PC Act in connection with the bid.
- v. We shall undertake that, the Employer i.e. NMPA is indemnified against all damages or compensation payable at Law in respect of or in consequence of any accident or injury to any workman or other person in the employment of the Contractor or Sub-Contractor against all claims, demands, proceedings, costs, charges and expenses whatsoever in respect thereof or in relation thereto and the Employer shall be at liberty to deduct or adjust from the Contractor's bills an amount that Employer may be called upon to pay towards claims, demands, proceedings, costs, charges and expenses Whatsoever in respect of or in relation to any accident or injury referred to above without any reference to the Contractor.
- vi. We shall comply with all the Central State and Municipal Laws and Rules and we shall be solely responsible for complying with the provisions of the Contract Labour (Regulations & Abolition) Act, 1970 & the contract labour (Regulation & Abolition) Karnataka Rules 1974 and rules there under and the enactments that may be applicable including ESI Act, the payment of wages act, Provident Fund Act, the Minimum Wages Act, the Factory's Act. The Workmen Compensation Act or any other applicable legislation and the Municipal by-laws or other

statutory Rules and Regulations whatsoever in force if these are applicable. Any obligations finding or otherwise missed under any statutory enactments, rules & regulations there under shall be the responsibility of the Contractor and the NMPA will take no responsibility for the same. The Contractor should take Workmen's Compensation Policy for his Workers, who are not covered under ESI and submit the same to the EIC immediately after commencement of the work.

- vii. We undertake that, we are liable to pay all Statutory Compensation to the Labourers/persons engaged by him for the satisfactory execution of the works. If any claim is made against New Mangalore Port Authority on this work, the Port Authority shall have the right to deduct the same from the bill amount payable to the contractor after verification of the validity and if admissible as per rules
- viii. We have not been barred by the [Central/ State] Government, or any entity controlled by it, from participating in any project and the bar subsist as on the due date of Tender.
- ix. *We disclose with that we have made / not made payments or propose to be made to any intermediaries (agents) etc in connection with the bid.

* Note: Delete whichever is not applicable.

Signature
(Authorised Signatory)

Annexure-9

BID SECURITY (BANK GUARANTEE) (Not applicable to this contract)

WHEREAS, _____ [Name of Bidder] (hereinafter called “the Bidder”) has submitted his bid dated _____ [date] for the Development of Garden adjacent to Godown No:31 and 32 at NMP(hereinafter called “the Bid”).

KNOW ALL PEOPLE by these presents that We _____ [name of bank] of _____ (name of country) having our registered office at _____ (hereinafter called “the Bank”) are bound unto The Board of New Mangalore Port Authority, a body constituted under Major Port Authority Act 2021 (hereinafter called “the Employer”) in the sum of Rs. 23900/- (Rupees TwentyThree Thousand Nine Hundred Only.)

i* for which payment well and truly to be made to the said Employer the Bank binds itself, his successors and assigns by these presents.

SEALED with the Common Seal of the said Bank this _____ day of _____ 2024

THE CONDITIONS of these obligations are:

- (1) If after Bid opening the Bidder withdraws his Bid during the period of bid validity specified in the Form of Bid;
- or
- (2) If the Bidder having been notified of the acceptance of his Bid by the Employer during the period of bid validity:
 - (a) fails or refuses to execute the Form of Agreement in accordance with the Instructions to Bidders, if required; or
 - (b) fails or refuses to furnish the Performance Security, in accordance with the Instructions to Bidders, or
 - (c) does not accept the correction of the Bid Price pursuant to Clause 27;

We undertake to pay to the Employer up to the above amount upon receipt of his first written demand, without the Employer having to substantiate his demand, provided that in his demand the Employer will note that the amount claimed by him is due to him owing to the occurrence of one or any of the three conditions, specifying the occurred condition or conditions.

This Guarantee will remain in force up to and including the date _____ ii* days after the deadline for submission of Bids as such deadline is stated in the Instructions to Bidders or as it may be extended by the Employer, notice of which extension(s) to the Bank is hereby waived. Any demand in respect of this Guarantee should reach the Bank not later than the above date.

Notwithstanding anything mentioned above, Our liability against this guarantee is restricted to Rs. 23900/- (Rupees TwentyThree Thousand Nine Hundred Only.) and unless a claim in writing is lodged with us within 3 months of the date of expiry or the extended date of expiry of this guarantee all our liabilities under this guarantee shall stand discharges.

IN WITNESS WHEREOF this guarantee has been duly executed on this day of
..... 2024

DATE _____ SIGNATURE OF THE BANK _____

WITNESS _____ SEAL _____

[Signature, name and address]

i*The Bidder should insert the amount of the guarantee in words and figures denominated in Indian Rupees. This figure should be the same as shown in Clause 16 of the Instructions to Bidders.

ii*30 days after the end of the validity period of the Bid.

Annexure-10DETAILS OF THE PARTY OPTING FOR REFUND OF EMD THROUGH E-PAYMENT
SYSTEM FROM NEW MANGALORE PORT AUTHORITY

Name of the Party :

Bank A/c No :

Account type : (Savings / Current / Overdraft)

Bank Name :

Branch :

IFSC Code Number : (11 digit code)

Centre (Location) :

FAX No. :

E-Mail ID : (For forwarding information of remittance)

Mobile No :

Signature of the Party

Annexure-11

FORMAT FOR FURNISHING BANK INFORMATION FOR e-PAYMENT

1	Name and full address of the beneficiary	
2	Credit Account No. (Should be full 14 digit)	
3	Account Type (SB or CA or OD)	
4	Name of the Bank	
5	Branch (Full address with telephone No.)	
6	IFSC Code Number (11 digit)	
7	MICR code (Should be 9 digit)	
8	Telephone/Mobile/Fax No. of the beneficiary	Telephone:
		Mobile :
		Fax :
9	Photostat copy of a Cheque	

Signature of the party with seal

Verified the details furnished by the party and it is ascertained that the information furnished are in full shape as required. Xerox copy of a Cheque is also enclosed.

Signature of the HOD/HOO with seal

Indemnity Bond

(To be furnished in Stamp paper not less than Rs.100 e-Stamp paper)

This deed of indemnity is executed by herein after referred to as 'Indemnifier' which expression shall unless repugnant to the context or meaning thereof, include its successors, Administrator, representatives and assignees in favour of New Mangalore Port Authority, Panambur, Mangalore 575010, herein after referred to as 'Indemnified' which expression shall unless repugnant to the context or meaning thereof include its representatives and assignees witnesses as to.

Whereas the indemnified herein as awarded to the indemnifier herein a Tender/Contract or for on terms and conditions set out interalia in the work order No..... valued at Rs.....

AND Whereas, the clauses No..... of the above mentioned work order provides for indemnifying the indemnified by the indemnifier for any accident, damage or compensation payable to any workmen or other person in the employment of the contractor or any sub contractor during the period of tender/contract.

AND Whereas, the Indemnifier hereby irrevocably agrees to indemnify the indemnified against all damages or compensation payable at law in respect of or in consequence of any accident or injury to any workmen or other person in the employment of the contractor or sub-contractor against all claims, demands, proceedings, costs, charges and expenses whatsoever in respect thereof or in relation thereto and the indemnified shall be at liberty to deduct or adjust from the bills payable to the indemnifier by the indemnified for an amount that the indemnified may be called upon to pay towards claims, demands, proceedings, costs, charges and expenses whatsoever in respect of or in relation to any accident or injury referred to above without any reference to the indemnifier.

The Indemnifier shall comply with all the Central State and Muncipal Laws and Rules and shall be solely responsible for complying with the provisions of the Contract Labour (Regulations & Abolition) Act, 1970 & the contract labour (Regulation & Abolition) Karnataka Rules 1974 and rules there under and the enactments that may be applicable including ESI Act, the payment of wages act, Provident Fund Act, the Minimum Wages Act, the Factory's Act, the Workmen Compensation Act or any other applicable legislation and the Muncipal by-laws or other statutory Rules and

Regulations whatsoever in force if these are applicable. Any obligations finding or otherwise missed under any statutory enactments rules & regulations there under shall be the responsibility of the Indemnifier and the Indemnified will have no responsibility for the same. The Indemnifier shall obtain Workmen’s Compensation Policy for his workers, who are not covered under ESI and submit the same to the ESIC immediately after commencement of the work.

The Indemnifier is liable to pay all Statutory Compensation to the Labourers / persons engaged by him for the satisfactory execution of the works. If any claim is made against Indemnified arising out of this work, the Port shall have the right to deduct the same from the bill amount payable to the Indemnifier after verification of the validity and if admissible as per rules.

The Indemnifier shall ensure the use of PPE such as helmets, safety shoes, nose masks, hand gloves, safety harness or any other equipment as required depending on nature of work by his staff at site.

In addition to complying of the above, the Indemnifier hereby undertakes to indemnify the indemnified against any unforeseen incidents / accidents, which may lead to fatality including death, permanent/ partial disablement, injury, financial loss, legal issues or any other etc of the labourers / workmen’s/ staffs of the contractor / sub-contractor for which the indemnified and its officers / representation are in no way responsible.

For.....

INDEMINIFIER

(Signature with Name and Designation)

Company Seal

Station:

Date:

**Format for Self Certification under Preference to “MAKE
IN INDIA” Policy**

(Refer Clause No. 38 of ITT)

CERTIFICATE

In line with Government Public Procurement Order No. P-45021/2/2017-PP(B-II) dtd. 16-09-2020, as amended from time to time and as applicable on the date of submission of tender, we hereby certify that we M/s_____ (name of the Bidder) are local supplier meeting the requirement of minimum Local content (50%) as defined in above orders for the material against Tender NIT No_____ for the work of _____

—
Details of location at which local value addition will be made is as follows:

We also understand, false declarations will be in breach of the Code of Integrity under Rule 175(1)(i)(h) of the General Financial Rule for which for which a bidder or its successors can be debarred for up two years as per Rule 151 (iii) of the General Financial Rules along with such other actions as may be permissible under law. Seal and Signature of Authorized Signatory

Signature of the Bidder

Date :

Place :

BID SECURITY DECLARATION FORM

Date: [insert date (as day, month and year)]

NIT No: CIVIL/CE(C)/EE(C)/83/2024-25 dtd. 11-03-2025 TENDER ID:
2025_NMPT_852770_1

Name of Work : Development of Garden adjacent to Godown No:31 and 32 at NMPTo:

The Executive Engineer (Civil)

New Mangalore Port Authority,

NMPA, Panambur – 575 010

I/We. The undersigned, declare that:

I/We understand that, according to your conditions, bids must be supported by a Bid security declaration

I/We accept that we will automatically be disqualified from bidding for any contract with New Mangalore Port Trust for a period of 2 (two) years starting from the date of notification from the Employer, if the undertaking of the affidavit submitted by us or our constituents in pursuance to any of the declarations of Letter of Technical Bid or Letter of Price Bid submitted by us are found to be false at any stage during the process of bid evaluation; or

I am / We are in a breach of any obligation(s) under the bid conditions, because I/We

- a) have withdrawn / modified / amended, impairs or derogates from the bid, my / our Bid during the period of bid validity specified in the form of Bid; or
- b) do not accept the correction of errors in accordance with the Instructions to Bidders; or
- c) having been notified of the acceptance of our Bid by the employer during the period of bid validity,
 - i. fail or refuse to execute the contract, if required; or
 - ii. fail or refuse to furnish the Performance Security, in accordance with the Instructions to Bidders; or
 - iii. fail or refuse to furnish a domestic preference security, if required.

I/We understand this Bid Security Declaration shall cease to be valid if I am/we are not the successful Bidder, upon the earlier of

- i. the receipt of your notification of the name of the successful Bidder; or
- ii. 28 (Twenty eight) days after the expiration of the validity of my/our Bid

Signed: [insert signature of person whose name and capacity are shown]

In the capacity of [insert legal capacity of person signing the Bid-Securing Declaration]

Name: [insert complete name of person signing the Bid-security Declaration]

Duly authorized to sign the bid for and behalf of [insert complete name of the Bidder]

Dated on _____ day of _____, _____ [insert date of Signing]

Signature of the Bidder
Corporate seal [where appropriate]

SECTION - II

iii) FORM OF AGREEMENT

THIS AGREEMENT made the _____ day of _____
 20__ BETWEEN New Mangalore Port Authority (hereinafter called "the Employer")
 of the one part and _____

(hereinafter called "the Contractor") of the other part WHEREAS the Employer is desirous that certain works should be executed by the Contractor, Viz----- and has accepted a Tender by the Contractor for the execution and Completion of such works and the remedying of any defects therein at a contract price of Rs

NOW THIS AGREEMENT WITNESSETH as follows:

- 1 In this Agreement words and expressions shall have the same meanings as are respectively assigned to them in the General Conditions hereinafter referred to.
2. The following documents shall be deemed to form and be read and construed as part of this Agreement, viz.-
 - a) The Letter of Acceptance;
 - b) The Said Tender (Technical Bid);
 - c) The Conditions of Contract (Parts I and II)
 - d) The Specifications;
 - e) The Drawings;
 - f) The Bill of Quantities and
 - g) The Addenda
 - h) Letters exchanged between the Employer and the Tenderer up to the issue of Letter of Acceptance as separately listed and annexed here to.
3. In consideration of the payments to be made by the Employer to the contractor as hereinafter mentioned the Contractor hereby covenants with the Employer to execute and complete the works and remedy any defects therein in conformity in all respect with the provisions of the Contract.
4. The Employer hereby covenants to pay the Contractor in consideration of the execution and completion of the works and the remedying of defects therein the Contract Price or and such other sum as may become payable under the Provisions of the Contract at the times and in the manner prescribed by the Contract.

IN WITNESS whereof the parties hereto have caused this Agreement to be executed the day and year first above written in accordance with their respective laws.

This document contains pages in all. This agreement is assigned No. CEA /20XX-XX.

The Common Seal of

was hereunto affixed in the presence of :

SECTION - III

iv) CONDITIONS OF CONTRACT

A. General**1. Definitions**

Terms which are defined in the Contract Data are not also defined in the Conditions of Contract but keep their defined meanings. Capital initials are used to identify defined terms.

Bill of Quantities means the priced and completed Bill of Quantities forming part of the Bid.

Compensation Events are those defined in Clause 44.

The Completion Date is the date of completion of the Works as certified by the Engineer or his nominee in accordance with Sub Clause 54

The Contract is the contract between the Employer and the Contractor to execute, complete and maintain the Works. It consists of the documents listed in Clause 2.3 below.

The Contract Data defines the documents and other information which comprise the Contract.

The Contractor is a person or corporate body whose Bid to carry out the Works has been accepted by the Employer.

The Contractor's Bid is the completed Bidding documents submitted by the Contractor to the Employer.

The Contract Price is the price stated in the letter of acceptance and thereafter as adjusted in accordance with the provisions of the Contract.

Days are calendar days, months are calendar months.

A Defect is any part of the Works not completed in accordance with the Contract.

The Defects Liability Period is the period named in the Contract Data and calculated from the Completion Date.

The Employer is the party who will employ the Contractor to carry out the Works.

Equipment is the Contractor's machinery and vehicles brought temporarily to the Site to construct the Works.

The Initial Contract Price is the Contract Price listed in the Employer's Letter of Acceptance.

The Intended Completion Date is the date on which it is intended that the Contractor shall complete the works. The Intended Completion Date is specified in the Contract Data. The Intended Completion Date may be revised only by the Engineer or his nominee by issuing an extension of time.

Materials are all supplies, including consumables, used by the contractor for incorporation in the Works.

The Engineer or his nominee is the person named in the Contract Data (or any other competent person appointed and notified to the contractor to act in replacement of the Engineer or his nominee) who is responsible for supervising the Contractor, administering the Contract, certifying payments due to the Contractor, issuing and valuing Variations to the Contract, awarding extensions of time and valuing the Compensation Events.

Plant is any integral part of the Works which is to have mechanical, electrical, electronic or chemical or biological function.

The Site is the area defined as such in the Contract Data.

Site Investigation Reports are those which are included in the Bidding documents and are factual interpretative reports about the surface and sub-surface conditions at the site.

Specification means the Specification of the Works included in the Contract and any modification or addition made or approved by the Engineer or his nominee.

The Start Date is given in the Contract Data. It is the date when the Contractor shall commence execution of the works. It does not necessarily coincide with any of the Site Possession Date.

A Subcontractor is a person or corporate body who has a Contract with the Contractor to carry out a part of the work in the Contract which includes work on the Site.

Temporary Works are works designed, constructed, installed and removed by the Contractor which are needed for construction or installation of the Works.

A Variation is an instruction given by the Engineer or his nominee which varies the Works.

The Works are what the Contract requires the Contractor to construct, install and turn over to the Employer as defined in the Contract Data.

The Trained Work Person are those employed / proposed to be employed by the Contractor at the Project Site, who have participated and are in possession of a valid Competency Certificate through a programme run under the auspices of a University, State Technical Board, Ministry of Government of India.

2. Interpretation

2.1 In interpreting these Conditions of Contract, singular also means plural, male also means female or neuter and the other way around. Headings have no significance. Words have their normal meaning under the language of the Contract unless specifically defined. The Engineer or his nominee will provide instructions clarifying queries about the Conditions of Contract.

2.2 If sectional completion is specified in the Contract Data, references in the

Conditions of Contract to the Works, the Completion Date, and the Intended Completion Date apply to any Section of the Works (other than references to the Completion Date and Intended Completion date for the whole of the Works).

- 2.3 The documents forming the Contract shall be interpreted in the following order of priority:
- (1) Agreement
 - (2) Letter of Acceptance and notice to proceed with works
 - (3) Contractor's Bid
 - (4) Contract Data
 - (5) Conditions of Contract including Special Conditions of Contract
 - (6) Specifications
 - (7) Drawings
 - (8) Bill of quantities and
 - (9) any other documents listed in the Contract Data as forming part of the Contract.

3. Language and Law

- 3.1 The language of the Contract and the law governing the Contract are stated in the Contract Data.

4. Engineer or his nominee's Decisions

- 4.1 Except where otherwise specifically stated, the Engineer or his nominee will decide contractual matters between the Employer and the Contractor in the role representing the Employer.

5. Delegation

- 5.1 The Engineer or his nominee may delegate any of the duties and responsibilities to other people after notifying the Contractor and may cancel any delegation after notifying the Contractor.

6. Communications

Communications between parties which are referred to in the conditions are effective only when in writing. A notice shall be effective only when it is delivered (in terms of Indian Contract Act 1872).

7. Contract Agreement

A suitable form is annexed as "FORM OF AGREEMENT" to the Contract Document. Upon signing the Contract Agreement, the Contractor shall make 10 copies of Contract Documents in hardbound cover which shall cover documents

used in Contract/Agreement and provide the same to the Employer at no extra cost.

Data made available by the Employer in accordance with provisions of the Condition of Contract shall be deemed to include data listed elsewhere in the Contract and open for inspection at the office of the Deputy Chief Engineer (Civil) of the New Mangalore Port Authority (by prior appointment with the Engineer). The work shall not be commenced without signing contract agreement.

8. Subcontracting

8.1 The Contractor may subcontract with the approval of the Engineer or his nominee but may not assign the Contract without the approval of the Employer in writing. Subcontracting does not alter the Contractor's obligations.

Other Contractors

8.2 The Contractor shall co-operate and share the site with other contractors, public authorities, utilities, and the Employer between the dates given in the Schedule of other contractors. The Contractor shall as referred to in the Contract Data, also provide facilities and services for them as described in the Schedule. The employer may modify the schedule of other contractors and shall notify the contractor of any such modification.

9. Personnel

9.1 The Contractor shall employ the key personnel named in the Schedule of Key Personnel as referred to in the Contract Data to carry out the functions stated in the Schedule or other personnel approved by the Engineer or his nominee. The Engineer or his nominee will approve any proposed replacement of key personnel only if their qualifications, abilities, and relevant experience are substantially equal to or better than those of the personnel listed in the schedule.

9.2 If the Engineer or his nominee asks the contractor to remove a person who is a member of the contractor's staff of his work force stating the reasons, the contractor shall ensure that the person leaves the site within seven days and has no further connections with the work in the contract.

10. Employer's and Contractor's Risks

10.1 The Employer carries the risks which this Contract states are Employer's risks and the contractor carries the risks which this Contract states are contractor's risks.

11. Employer's Risks

11.1 The Employers risks are

- a) in so far as they directly affect the execution of the Works in the country where the Permanent Works are to be executed:
 - i) war and hostilities (whether war be declared or not), invasion, act of foreign enemies;
 - ii) rebellion, revolution, insurrection, or military or usurped power, or civil war;
 - iii) ionizing radiations, or contamination by radioactivity from any nuclear fuel, or from any nuclear waste, from the combustion of nuclear fuel, radioactive toxic explosive or other hazardous properties of any explosive nuclear assembly or nuclear component thereof;
 - iv) pressure waves caused by aircraft or other aerial devices travelling at sonic or supersonic speeds; and
 - v) riot, commotion or disorder, unless solely restricted to the employees of the Contractor or of his Subcontractors and arising from the conduct of the Works;
 - vi) Unforeseen Rains (Rains if any; during the period other than the Monsoon period as stated in the Tender), floods, tornadoes, earthquakes and landslides.
- b) loss or damage due to the use or occupation by the Employer of any Section or part of the Permanent Works, except as may be provided for in the Contract;
- c) loss or damage to the extent that it is due to the design of the Works, other than any part of the design provided by the Contractor or for which the Contractor is responsible; and
- d) any operation of the forces of nature (in so far as it occurs on the Site) which an experienced contractor:
 - i) could not have reasonably foreseen, or
 - ii) could reasonably have foreseen, but against which he could not reasonably have taken at least one of the following measures:
 - A) prevent loss or damage to physical property from occurring by taking appropriate measures, or
 - B) insure against.

12. Contractor's Risks

12.1 All risks of loss of or damage to physical property and of personal injury and death which arise during and in consequence of the performance of the

Contract other than the excepted risks are the responsibility of the Contractor.

13. Insurance

13.1 The Contractor shall provide in the joint names of the Employer and the Contractor, insurance cover from the Start Date to the end of the Defects Liability Period, in the amounts and deductibles stated in the Contract Data for the following events which are due to the Contractors risks.

- a) loss of or damage to the Works, Plant and Materials
- b) loss of or damage to Equipment;
- c) loss of or damage of property (except the Works, Plant, Materials and Equipment) in connection with the Contract; and
- d) personal injury or death.

13.2 Policies and certificates for insurance shall be delivered by the contractor to the Engineer or his nominee for the Engineer or his nominee's approval before the start date. All such insurances shall provide for compensation to be payable in the types and proportions of currencies required to rectify the loss or damage incurred.

13.3 If the contractor does not provide any of the policies and certificates required, the Employer may affect the insurance which the contractor should have provided and recover the premiums the Employer has paid from payments otherwise due to the contractor or, if no payment is due, the payment of the premiums shall be a debt due.

13.4 Alterations to the terms of insurance shall not be made without the approval of the Engineer or his nominee.

13.5 Both parties shall comply with all conditions of the insurance policies.

14. Site Investigation Reports

The Contractor, in preparing the Bid, shall rely on the Site Investigation Report referred to in the Contract Data, supplemented by any information available to the Bidder.

15. Queries about the Contract Data

The Engineer or his nominee will clarify queries on the Contract Data.

16. Contractor to Construct the Works

The Contractor shall construct and install the works in accordance with the Specification and Drawings.

17. The Works to Be Completed by the Intended Completion Date

The Contractor may commence execution of the works on the Start Date and

shall carry out the works in accordance with the program submitted by the contractor as updated with the approval of the Engineer or his nominee, and complete them by the Intended Completion Date.

18. Approval by the Engineer or his nominee

18.1 The Contractor shall submit Specifications and Drawings showing the proposed Temporary Works to the Engineer or his nominee, who is to approve them if they comply with the specifications and Drawings.

18.2 The Contractor shall be responsible for design of Temporary Works.

18.3 The Engineer or his nominee's Approval shall not alter the contractor's responsibility for design of the Temporary Works.

18.4 All Drawings prepared by the contractor for the execution of the temporary or permanent Works, are subject to prior approval by the Engineer or his nominee before their use.

19. Safety

The contractor shall be responsible for the safety of all activities on the Site.

20. Discoveries

Anything of historical or other interest or of significant value unexpectedly discovered on the Site is the property of the Employer. The Contractor is to notify the Engineer or his nominee of such discoveries and carry out the Engineer or his nominee's instructions for dealing with them.

21. Possession of the Site

The Employer shall give possession of all parts of the Site to the Contractor, free from encumbrances. If possession of a part is not given by the start date stated in the Contract Data the Employer is deemed to have delayed the start of the relevant activities and this will be a Compensation Event.

22. Access to the Site

The Contractor shall allow the Engineer or his nominee and any person authorized by the Engineer or his nominee access to the Site to any place where work in connection with the Contract is being carried out or is intended to be carried out and to any place where materials or plant are being manufactured, fabricated and/or assembled for the works.

23. Instructions

The Contractor shall carry out all instructions of the Engineer or his nominee which comply with the applicable laws where the Site is located.

24. Disputes

If the Contractor believes that a decision taken by the Engineer or his nominee was either outside the authority given to the Engineer or his nominee by the Contract or that the decision was wrongly taken, the decision shall be referred to the Dispute Review Board (DRB) within 28 days of the notification of the Engineer or his nominee's decision.

25. Settlement of Disputes

25.1 If a dispute of any kind whatsoever arises between the Employer and the Contractor in connection with, or arising out of the Contract or the execution of the Works, whether during the execution of the Works or after their completion and whether before or after repudiation or after termination of the Contract, including any disagreement by either party with any action, inaction, opinion, instruction, determination, certificate or valuation of the Engineer or his nominee, the matter in dispute shall, in the first place be referred to the Disputes Review Board [DRB] established pursuant to Appendix 1 hereto.

Unless the Contract has already been repudiated or terminated or frustrated the Contractor shall in every case, continue to proceed with the Works with all due diligence and the Contractor and the Employer shall give effect forthwith to every decision of the Engineer or his nominee unless and until the same shall be revised, as hereinafter provided, in a Dispute Review Board Recommendation / Arbitral Award.

25.2 Arbitration

Any dispute in respect of in respect of contracts where party is dissatisfied by the Dispute Review Board's (DRB) decision shall be decided by arbitration as set forth below:

- i) A dispute with contractor shall be finally settled by arbitration in accordance with the Indian Arbitration and Conciliation Act, 1996, or any statutory amendment thereof. The arbitral tribunal shall consist of 3 arbitrators, one each to be appointed by the Employer and the contractor, and the third to be appointed by the mutual consent of both the arbitrators, failing which by making a reference to CIDC-SIAC Arbitration Center from their panel.
- ii) Neither party shall be limited in the proceedings before such arbitrators to the evidence or arguments already put before the Engineer or his nominee or the Board, as the case may be, for the purpose of obtaining said recommendations/decision. No such recommendations/decision shall disqualify the Engineer or his nominee or any of the members of the Board, as the case may be, from being called as a witness and giving

evidence before the arbitrators or any matter whatsoever relevant to the dispute.

- iii) The reference to arbitration shall proceed notwithstanding that the works shall not then be or be alleged to be complete, provided always that the obligations of the Employer, the Engineer or his nominee and the Contractor shall not be altered by reason of the arbitration being conducted during the progress of the works. Neither party shall be entitled to suspend the works to which the dispute relates, and payment to the Contractor shall be continued to be made as provided by the contract.
- iv) If one of the parties fails to appoint its arbitrators in pursuance of sub-clause [i], within 14 days after receipt of the notice of the appointment of its arbitrator by the other party, then President/Chairman of the nominated Institution shall appoint arbitrator within 14 days of the receipt of the request by the nominated institution. A certified copy of the President's/ Chairman's order, making such an appointment shall be furnished to both the parties.
- v) Arbitration proceedings shall be held at Mangalore, and the language of the arbitration proceedings and that of all documents and communications between the parties shall be 'English
- vi) The Arbitration shall be conducted by the experts from the panel of CIDCSIAC Arbitration Center.
- vii) The decision of the majority of arbitrators shall be final and binding upon both parties. The expenses of the arbitrators as determined by the arbitrators shall be shared equally by the Employer and the Contractor. However, the expenses incurred by each party in connection with the preparation, presentation, etc. of its case prior to, during and after the arbitration proceedings shall be borne by each party itself.
- viii) All arbitration awards shall be in writing and shall state the reasons for the award.
- ix) Performance under the contract shall continue during the arbitration proceedings and payments due to the contractor by the Employer shall not be withheld, unless they are subject matter of the arbitration proceedings.

26. Replacement of Conciliator (Deleted)

B. TIME CONTROL**27. Program**

- 27.1 Within the time stated in the Contract Data the Contractor shall submit to the Engineer or his nominee for approval a Program showing the general methods, arrangements, order, and timing for all the activities in the works along with monthly cash flow forecast.
- 27.2 An update of the Program shall be a program showing the actual progress achieved on each activity and the effect of the progress achieved on the timing of the remaining work including any changes to the sequence of the activities.
- 27.3 The Contractor shall submit to the Engineer on the first day of each week or such longer period as the Engineer may from time to time direct, a progress report in an approved form showing up-to-date total progress, progress achieved against planned progress, during the previous week and progress forecast for the following week for all important items in each section or portion of the Works, in relation with the approved Program.
- 27.4 The Contractor shall submit to the Engineer or his nominee, for approval an updated Program at intervals no longer than the period stated in the Contract Data. If the Contractor does not submit an updated Program within this period, the Engineer or his nominee may withhold the amount stated in the Contract Data from the next payment certificate and continue to withhold this amount until the next payment after the date on which the overdue Program has been submitted.

28. Revised Program

The Engineer or his nominee's approval of the Program shall not alter the Contractor's obligations. The Contractor may revise the Program and submit it to the Engineer or his nominee again at any time. A revised Program is to show the effect of Variations and Compensation Events.

29. Extension of the Intended Completion Date

- 29.1 The Engineer or his nominee shall extend the Intended Completion Date if a Compensation Event occurs or a Variation is issued which makes it impossible for Completion to be achieved by the Intended Completion Date without the Contractor taking steps to accelerate the remaining work and which would cause the Contractor to incur additional cost.
- 29.2 The Engineer or his nominee shall decide whether and by how much to extend the Intended Completion Date within 21 days of the Contractor asking the Engineer or his nominee for a decision upon the effect of a

Compensation Event or Variation and submitting full supporting information. If the Contractor has failed to give early warning of a delay or has failed to cooperate in dealing with a delay, the delay by this failure shall not be considered in assessing the new Intended Completion Date.

30. Delays Ordered by the Engineer or his nominee

The Engineer or his nominee may instruct the Contractor to delay the start or progress of any activity within the Works.

31. Management Meetings

- 31.1 Either the Engineer or his nominee or the Contractor may require the other to attend a management meeting. The business of a management meeting shall be to review the plans for remaining work and to deal with matters raised in accordance with the early warning procedure.
- 31.2 The Engineer or his nominee shall record the business of management meetings and is to provide copies of his record to those attending the meeting and to the Employer. The responsibility of the parties for actions to be taken is to be decided by the Engineer or his nominee either at the management meeting or after the management meeting and stated in writing to all who attended the meeting.

32. Early Warning

- 32.1 The Contractor is to warn the Engineer or his nominee at the earliest opportunity of specific likely future events or circumstances that may adversely affect the quality of the work, increase the Contract Price or delay the execution of works. The Engineer or his nominee may require the Contractor to provide an estimate of the expected effect of the event or circumstance on the Contract Price and Completion Date. The estimate is to be provided by the Contractor as soon as reasonably possible.
- 32.2 The Contractor shall cooperate with the Engineer or his nominee in making and considering proposals for how the effect of such an event or circumstance can be avoided or reduced by anyone involved in the work and in carrying out any resulting instruction of the Engineer or his nominee.

C. QUALITY CONTROL

33. Identify Defects

The Engineer or his nominee shall check the Contractor's work and notify the Contractor of any Defects that are found. Such checking shall not affect the Contractor's responsibilities. The Engineer or his nominee may instruct the Contractor to search for a Defect and to uncover and test any work that the Engineer or his nominee considers may have a Defect.

34. Tests

If the Engineer or his nominee instructs the Contractor to carry out a test not specified in the Specification to check whether any work has a Defect and the test shows that it does the Contractor shall pay for the test and any samples. If there is no Defect the test shall be a Compensation Event.

35. Defect Liability

35.1 The Engineer or his nominee shall give notice to the Contractor of any Defects before the end of the Defects Liability Period, which begins at Completion and is defined in the Contract Data. The Defects Liability Period shall be extended for as long as Defects remain to be corrected.

35.2 Every time notice of a Defect is given, the Contractor shall correct the notified defect within the length of time specified by the Engineer or his nominee's notice. To the intent that the works shall, at or as soon as practicable after the expiration of the Defects Liability Period, be delivered to the Employer in the condition required by the Contract, fair wear and tear excepted, to the satisfaction of the Engineer, the Contractor shall :

- (a) Complete the work, if any, outstanding on the date stated in the Taking-Over Certificate within the date to be intimated by the engineer and
- (b) execute all such work of amendment, reconstruction, and remedying defects, shrinkages or other faults as the Engineer may, during the Defects Liability Period or within 14 days after its expiration, as a result of an inspection made by or on behalf of the Engineer prior to its expiration, instruct the Contractor to execute.

35.3 Cost of Remedying Defects

All work referred to in Sub-Clause 35.2 shall be executed by the contractor at his own cost if the necessity thereof is, in the opinion of the Engineer, due to:

- a) The use of materials, Plant or workmanship not in accordance with the Contract, or

- b) Where the Contractor is responsible for the design of part of the Permanent Works, any fault in such design, or the neglect or failure on the part of the Contractor to comply with any obligation, expressed or implied, on the Contractor's part under the Contract.

35.4 Defects Liability Certificate

The Contract shall not be considered as completed until a Defects Liability Certificate shall have been signed by the Engineer and delivered to the Employer, with a copy to the Contractor, stating the date on which the Contractor shall have completed his obligations to execute and complete the Works and remedy any defects therein to the Engineer's satisfaction. The Defects Liability Certificate shall be given by the Engineer within 28 days after the expiration of the Defects Liability Period, or, if different defects liability periods shall become applicable to different Sections or parts of the Permanent Works, the expiration of the latest such period, or as soon thereafter as any works instructed, pursuant to Clauses 35, have been completed to the satisfaction of the Engineer.

35.5 Unfulfilled Obligations

Notwithstanding the issue of the Defects Liability Certificate the Contractor and the Employer shall remain liable for the fulfillment of any obligation incurred under the provisions of the Contract prior to the issue of the Defects Liability Certificate which remains unperformed at the time such Defects Liability Certificate is issued and, for the purposes of determining the nature and extent of any such obligation, the Contract shall be deemed to remain in force between the parties to the Contract.

36. Uncorrected Defects.

If the Contractor has not corrected a Defect within the time specified in the Engineer or his nominee's notice the Engineer or his nominee will assess the cost of having the Defect corrected, and the Contractor will pay this amount.

D. COST CONTROL

37. Bill of Quantities

- 37.1 The Bill of Quantities shall contain items for the construction, supply, installation, testing and commissioning work to be done by the Contractor.
- 37.2 The Bill of Quantities is used to calculate the Contract Price. The Contractor is paid for the quantity of the work done at the rate in the Bill of Quantities for each item.

38. Changes in the Quantities

- 38.1 If the final quantity of the work done differs from the quantity in the Bill of Quantities for the particular item by more than +25 % provided the change exceeds +10% of initial Contract Price, the Engineer or his nominee shall adjust the rate(s), to allow for the change.
- 38.2 The Engineer or his nominee shall not adjust rates from changes in quantities if thereby the Initial Contract Price is exceeded by more than 15 percent except with the Prior approval of the Employer.
- 38.3 If requested by the Engineer or his nominee where the quoted rate(s) of any item(s) is abnormally high, the Contractor shall provide the Engineer or his nominee with a detailed cost breakdown of such rate in the Bill of Quantities.

39. Variations

- 39.1 The Engineer shall make any variation of the form, quality or quantity of the Works or any part thereof that may, in his opinion, be necessary and for that purpose, or if for any other reason it shall, in his opinion, be appropriate, he shall have the authority to instruct the Contractor to do and the Contractor shall do any of the following:
- a) increase or decrease the quantity of any work included in the Contract,
 - b) omit any such work,
 - c) change the character or quality or kind of any such work,
 - d) change the levels, lines, position and dimension of any part of the Works,
 - e) execute additional work of any kind necessary for the completion of the Works,
 - f) change any specified sequence or timing of construction of any part of the Works.
- No such variation shall in any way vitiate or invalidate the Contract, by the effect, if any, of all such variations shall be valued in accordance with Clause 40. Provided that where the issue of an instruction to vary the

works is necessitated by some default of or breach of contract by the contractor or for which he is responsible, any additional cost attributable to such default shall be borne by the contractor. All Variations shall be included in updated Programs produced by the contractor.

39.2 Instructions for Variations

The Contractor shall not make any such variation without an instruction of the Engineer. Provided that no instruction shall be required for increase or decrease in the quantity of any work where such increase or decrease is not the result of an instruction given under this clause, but is the result of the quantities exceeding or being less than those stated in the Bill of Quantities.

40. Payments for Variations

- 40.1 Variation permitted shall not exceed +25% in quantity of each individual item, and +10% of the total contract price. Within 14 days of the date of instruction for executing varied work, extra work or substitution, and before the commencement of such work, notice shall be given either (a) by the contractor to the Employer of his intention to claim extra payment or a varied rate or price, or (b) by the Employer to the contractor of his intention to vary rate or price.
- 40.2 For items not existing in the Bill of Quantities or substitution to items in the Bill of Quantities, rate payable should be determined by methods given below and in the order given below:
- i) Rates and prices in Contract, if applicable plus escalation as per contract.
 - ii) Rates and prices in the Schedule of Rates applicable to the Contract plus ruling percentage.
 - iii) Market rates of materials and labor, hire charges of plant and machinery used, plus 10% for overheads and profits of contractor.
- 40.3 For items in the Bill of Quantities but where quantities have increased beyond the variation limits, the rate payable for quantity in excess of the quantity in the Bill of Quantity plus the permissible variation should be:
- i) Rates and prices in contract, if reasonable plus escalation, failing which (ii) and (iii) below will apply
 - ii) Rates and prices in the schedule of Rates applicable to the contract plus ruling percentage.
 - iii) Market rates of material and labor, hire charges of plant and machinery used plus 10% for overheads and profits of contractor.
- 40.4 If there is delay in the Employer and the Contractor coming to an agreement on the rate of an extra item, rates as proposed by the Employer

shall be payable provisionally till such time as the rates are finally determined or till date mutually agreed.

- 40.5 If the Engineer or his nominee decides that the urgency of varying the work prevent a quotation being given and considers not delaying the work, no quotation shall be given and the Variation shall be treated as a Compensation Event.

41. Cash flow forecasts

- 41.1 When the Program is updated, the contractor is to provide the Engineer or his nominee with an updated cash flow forecast.

42. Payment Certificates

- 42.1 The Contractor shall submit to the Engineer or his nominee monthly statements of the estimated value of the work completed less the cumulative amount certified previously.
- 42.2 The Engineer or his nominee shall check the Contractors' monthly statement within 14 days and certify the amount to be paid to the Contractor after taking into account any credit or debit for the month in question in respect of materials for the works in the relevant amounts and under conditions set forth in sub-clause 51.6 of the Contract Data (Secured Advance).
- 42.3 The value of work executed shall be determined by the Engineer or his nominee.
- 42.4 The value of work executed shall comprise the value of the quantities of the items in the Bill of quantities completed.
- 42.5 The value of work executed shall include the valuation of variations and Compensation Events.
- 42.6 The Engineer or his nominee may exclude any item certified in a previous certificate or reduce the proportion of any item previously certified in any certificate in the light of later information.

43. Payments

- 43.1 Bills /Tax invoice shall be prepared and submitted by the Contractor. Joint measurements shall be taken continuously and need not be connected with billing stage. System of 4 copies of measurements, one each for Contractor, Employer and Engineer or his nominee, and signed by both Contractor and Employer shall be followed.
- 43.2 75% of bill amount shall be paid within 14 days of submission of the bill. Balance amount of the verified bill shall be paid within 28 days of the submission of the bill.
- 43.3 Contractor shall submit final Bill within 60 days of issue of defects liability certificate. Client's Engineer or his nominee shall check the bill within 60 days after its receipt and return the bill to Contractor for corrections, if any. 50% of undisputed amount shall be paid to the Contractor at the stage of returning the bill.
- 43.4 The contractor should re-submit the bill, with corrections within 30 days of its return by the Engineer or his nominee. The re-submitted bill shall be checked and paid within 60 days of its receipt.
- 43.5 If an amount certified is increased in a later certificate as a result of an award by the DRB or an Arbitrator, the Contractor shall be paid interest upon the delayed payment as set out in this clause. Interest shall be calculated from the date upon which the increased amount would have been certified in the absence of dispute.
- 43.6 Items of the Works for which no rate or price has been entered in will not be paid for by the Employer and shall be deemed covered by other rates and prices in the Contract.

44. Compensation Events

- 44.1 The following mutually agreed Compensation Events unless they are caused by the Contractor would be applicable:
 - (a) The Employer does not give access to a part of the Site by the Site Possession Date stated in the Contract Data.
 - (b) The Employer modifies the schedule of other contractors in a way which affects the work of the contractor under the contract.
 - (c) The Engineer or his nominee orders a delay or does not issue drawings, specifications or instructions required for execution of works on time.
 - (d) The Engineer or his nominee instructs the Contractor to uncover or to carry out additional tests upon work which is then found to have

- no Defects.
- (e) The Engineer or his nominee unreasonably does not approve for a subcontract to be let.
 - (f) Ground conditions are substantially more adverse than could reasonably have been assumed before issuance of Letter of Acceptance from the information issued to Bidders (including the Site Investigation Reports), from information available publicly and from a visual inspection of the site.
 - (g) The Engineer or his nominee gives an instruction for dealing with an unforeseen condition, caused by the Employer, or additional work required for safety or other reasons.
 - (h) Other contractors, public authorities, utilities or the Employer does not work within the dates and other constraints stated in the Contract that cause delay or extra cost to the Contractor.
 - (i) The effect on the Contractor of any of the Employer's Risks.
 - (j) Other Compensation Events listed in the Contract Data or mentioned in the contract.

Whenever any compensation event occurs, the contractor will notify the employer, within 14 days and provide a forecast cost of the compensation event.

44.2 If a Compensation Event would cause additional cost or would prevent the work being completed before the Intended Completion Date, the Contract Price shall be increased and/or the Intended Completion Date shall be extended. The Engineer or his nominee shall decide whether and by how much the Contract Price shall be increased and whether and by how much the Intended Completion Date shall be extended.

44.3 As soon as information demonstrating the effect of each Compensation Event upon the Contractor's forecast has been provided by the Contractor, it is to be assessed by the Engineer or his nominee and the Contract Price shall be adjusted accordingly. If the Contractor's forecast is deemed unreasonable the Engineer or his nominee shall adjust the Contract Price based on Engineer or his nominee's own forecast. The Engineer or his nominee will assume that the Contractor will react competently and promptly to the event.

45. Tax

45.1 The rates quoted by the Contractor to be inclusive of Taxes if any excluding GST that the Contractor will have to pay for the performance of this Contract. The Employer will perform such duties in regard to the deduction of such taxes at sources as per applicable law. Any new Taxes, levies, duties imposed after signing the Contract shall be reimbursed by

the employer on production of documentary evidence.

The GST shall be quoted separately in tax invoice.

The Contractor shall file the applicable returns with tax department in time and submit the same as documentary evidence.

46. Currencies

46.1 All payments shall be made in Indian Rupees unless specifically mentioned.

47. Price Adjustment. (Not Applicable)

47.1 Contract price shall be adjusted for increase or decrease in rates and prices of labour, materials, fuels and lubricants in accordance with the following principles and procedures and as per formula given below:

- (a) The price adjustment shall apply for the work done from the start date given in the contract data up to end of the initial intended completion date or extensions granted by the Engineer or his nominee and shall not apply to the work carried beyond the stipulated time for reason attributable to the contractor.
- (b) The price adjustment shall be determined during each quarter from the mutually agreed formula given in the contract data based on the following premises.

I (A) Formula for Labour Component

V1	=	0.85	x	(R-C)	x	K1	x	I - I0
						100	x	I0

Where V1 = Amount of variation payable for a value R of work done.

R = Value of work done during the period under consideration.

C = Cost of Cement & steel calculated on star rates for quantity as per design, incorporated in to the work during the period under consideration to be taken from II A and II B.

K1 = Percentage of Labour Component to be taken as 25%.

I0 = Basic Consumer Price Index for Bangalore Centre (Base 2001 = 100) for industrial workers declared as per the Labour Bureau, Ministry of Labour & Employment, Government of India as prevailing on the Base Date (28 days prior to the latest date for submission of the Bid).

I = Average Consumer Price Index for Bangalore Centre (Base 2001 = 100) for industrial workers declared by the Labour Bureau, Ministry of Labour & Employment, Government of India for the period in which the value R of work is

done. If the period covered by a bill does not coincide with a calendar month, then weighted time average for the period will be taken for I.

I (B) Formula for Balance Material Component (excluding cement, steel).

V2	=	0.85	x	(R-C)	x	$\frac{K2}{100}$	x	$\frac{M - M0}{M0}$
----	---	------	---	-------	---	------------------	---	---------------------

Where V2 = Amount of variation payable for a value R of work done on account of material.

R = Value of work done during the period under consideration.

C = Cost of Cement and steel at Star rate calculated on star rates for quantity as per design, incorporated in to the work during the period under consideration to be taken from II A and II B.

K2 = Percentage of Material Component to be taken as 70%.

M0= Wholesale price index for all commodities prepared by the office of Economic Advisor, Ministry of Industry, Government of India as prevailing on the Base Date (28 days prior to the latest date for submission of the Bid).

M = Average wholesale price index for all commodities prepared by the office of Economic Advisor, Ministry of Industry, Government of India, during the period under consideration. If the period covered by a bill does not coincide with a calendar month, then weighted time average for the period will be taken for M.

I (C) Formula for Petrol, Oil and Lubricant (POL) Component

V3	=	0.85	x	(R-C)	x	$\frac{K3}{100}$	x	$\frac{P - P0}{P0}$
----	---	------	---	-------	---	------------------	---	---------------------

Where V3 = Amount of variation payable for a value R of work done on account of POL component.

R= Value of work done during the period under consideration.

C = Cost of Cement & steel calculated on star rates for quantity as per design/specification, incorporated in to the work during the period under consideration to be taken from II A and II B .

K3 = Percentage of POL Component to be taken as 5%.

P0= The price (average of the prices declared by IOC/HPCL/BPCL) of HSD for Mangalore on the Base Date (28 days prior to the latest date for submission of the Bid).

P = Average Price (average of the prices declared by IOC/HPCL/BPCL) of HSD-

RSP (Rs/litre) for Mangalore during the period under consideration.

After removal of actual cost of cement & steel for B above, price adjustment for the cost of cement and steel will be made as follows:

Price Adjustment

(II) (A) For Cement

Pc	=	Rc	x	Qcc	x	Ic – I0c
						I0c

Where Pc = Price adjustment for cement

Rc = Rate per MT of cement prevailing on the Base Date (28 days prior to the latest date for submission of the Bid) i.e. Star Rate.

Ic = Average Index for cement published by the Reserve Bank of India (source: office of the economic advisor, Ministry of commerce & Industry Government of India) under "Index numbers of Wholesale Prices by Group and Sub-Groups (Monthly data) under Group (1) – Non Metallic Mineral Products Sub-Group (C) – Cement and Lime, " or Monthly whole sale price index published by the office of economic advisor, government of India under cement & Lime forming the base forming the base of calculation for index of wholesale prices during the period under consideration.

I0c = Index for cement published by the Reserve Bank of India (source: office of the economic advisor, Ministry of commerce & Industry Government of India) under Index numbers of Wholesale Prices by Group and Sub-Group (Monthly data) under Group (1) – Non Metallic Mineral Products Sub-Group (C) – Cement & Lime or Monthly whole sale price index published by the office of economic advisor, government of India under cement & Lime forming the base of calculation for index of wholesale prices on the date 28 days preceding the latest date prescribed for the receipt of the Bid.

Qcc = Quantity in MT of cement as per design incorporated in to the work during the period under consideration.

II (B) For Steel

Ps	=	Rs	x	Qsc	x	Is – I0s
						I0s

Where Ps = Price adjustment for steel

Rs = Rate per MT of steel prevailing on the Base Date (28 days prior to the latest date for submission of the Bid). i.e. Star rate.

Is = Average Index for iron and steel published by the Reserve Bank of India

(source: office of the economic advisor, Ministry of commerce & Industry Government of India) under "Index numbers of Wholesale Prices by Group and Sub-Groups (Monthly data) under Group (J) – Basic Metals, Alloys & Metal Products, Sub-Group (a) Ferrous metals – (a1) Iron & Semis" or Monthly whole sale price index published by the office of economic advisor, government of India under Iron & Semis forming the base of calculation for index of wholesale prices during the period under consideration.

- a. I_{os} = Average Index for Iron and Steel published by the Reserve Bank of India (source: office of the economic advisor, Ministry of commerce & Industry Government of India) under "Index numbers of Wholesale Prices by Group and Sub-Groups (Monthly data) under Group (J) – Basic Metals, Alloys & Metal Products, Sub-Group (a) Ferrous metals – (a1) Iron & Semis" or Monthly whole sale price index published by the office of economic advisor, government of India under Iron & Semis forming the base forming the base of calculation for index of prices on the date 28 days preceding the latest date prescribed for the receipt of the Bid.

Q_{sc} = Quantity in MT of steel as per design incorporated in to the work during the period under consideration.

Notes:

- (i) The quantities of cement and steel considered for working out price variation shall be certified by the Engineer based on approved designs and as consumed in the work excluding wastage.
 - (ii) The time for completion of the contract shall mean the period commencing from the date of the commencement of the contract and ending on the date when the time allowed for the work specified expires, taking into consideration the extension of time, if any, for completion of the work granted by the Engineer under the relevant clause or the conditions of contract in cases other than those where such extension is necessitated on account of default of the contractor. The decision of the Engineer as regards the time of completion of the contract shall be final, conclusive and binding on the contractor, where compensation for delay is levied on the contractor on account of delay in completion or inadequate progress under the relevant contract provision the escalation amount for the balance work from the date of levy of such compensation shall be worked out as follows:
Indices I, M, P, Ic, & Is will be pegged to the levels corresponding to the date from which such compensation for delay is levied.
- b. Pegged indices as well as actual indices prevailing at the time of calculation of escalation for the period under consideration will be compared and lower

of the two will be taken for calculating actual escalation amount.

- (iii) Price variation shall be calculated in accordance with the formulae mentioned at (I)(A)(B) above, separately for labour, material and POL components, as well as for price adjustment for cement and steel in accordance with formulae mentioned at (II) (A) and(B) above. The relevant websites for ascertaining the various indices are as follows:
<http://www.iocl.com/Products/HighSpeedDiesel.aspx>
http://rbidocs.rbi.org.in/rdocs/Bulletin/PDFs/38T_BUL110610.pdf
<http://labourbureau.gov.in/indtab.pdf>
<http://indiabudget.nic.in/es2006-07/chapt2007/tab53.pdf>
<http://www.eaindustry.nic.in/default.html>
<http://labourbureau.nic.in/indnum.htm>
- (iv) The price variation under clause 47.1 shall not be payable for the extra items required to be executed during the progress of the work and where the rates payable for the extra items have been fixed as per the current market rates provided under Clause of General Conditions of Contract or mutually agreed.
- (v) The clause No.47.1 is operative both ways, i.e. if the price variation in the said Wholesale Price Index for all commodities, Consumer Price Index (New Series) or price of HSD of Bangalore or cost of cement or steel or bitumen is on the plus side, payment on account of the price variation shall be allowed to the Contractor and if it is on the negative side, the NMPA shall be entitled to recover the same from the contractor and the amount shall be deductible from the Contractor's bill for the respective period in which there are fluctuation.
- (vi) In order to facilitate computation of price variation to be made under clause 47.1 the contractor shall keep such books of accounts and other documents as are necessary. The contractor shall allow inspection of the same by an Engineer or his nominee and shall at the request of the Engineer may require true copies of any document so kept and such other information as the Engineer may require for verification.
- (vii) Calculation of Price Variation and Price Adjustment amount at the time of preparation of interim and final bill will be based on confirm indices and the prices of the POL products and bitumen products declared by IOC/BPCL/HPCL.
- (viii) Save and except for what is provided in the foregoing clause, nothing herein shall be construed to entitle the contractor to reimbursement of any increase in the price of materials or in the wages of labour occurring at any time and for any reason whatsoever, including the

imposition of any tax, duty or fee or an increase in the price of any petroleum product, coal, electricity or water effected by or under the order of the Central Government of a State Government.

- (ix) The basic price (star rate) will be fixed as per the prevailing rate at the time of invitation of the tender before 28 days from date of submission of the tenders.
 - (x) The mobilization and de-mobilization shall not be considered for calculation of Price Variations and the price variation for the items quoted on Lump sum basis shall not be payable .
- 47.2 To the extent that full compensation for any rise or fall in costs to the contractor is not covered by the provisions of this or other clauses in the contract, the unit rates and prices included in the contract shall be deemed to include amount to cover the contingency of such other rise or fall in costs.

47.3 Subsequent Legislation

If, after the date 28 (Twenty eight) days prior to the date for submission of tenders for the contract there occur changes to any National or Statute Stature, Ordinance or Decree or other Law or any regulation or bye law of any local or other duly constituted authority or introduction of any such state statute, Ordinance, Decree, Law, regulation or bye law which causes additional or reduced cost to the contractor in execution of the contract, such additional or reduced cost shall, after due consultation with the Employer and the contractor be determined by the Engineer or his nominee and shall be added to or deducted from the contract price and the Engineer or his nominee shall notify the contractor accordingly with a copy to the Employer.

48. Retention

- 48.1 The Employer shall retain from each payment due to the Contractor the proportion stated in the Contract Data until Completion of the whole of the Works.
- 48.2 Retention Money shall be deducted at the rate of 10% from first Running Bill onwards subject to a max. of 5% of the contract price (Contract price including GST). Retention money shall be refunded after completion of defect liability period along with performance security.

49. Liquidated Damages

- 49A In case of delay in completion of the contract, liquidated damages (L.D) may be levied at the rate of half per cent (½%) of the contract price per week of delay, or part thereof subject to a maximum of 10 per cent of the

contract price.

49A(i) The Employer, if satisfied, that the works can be completed by the contractor within a reasonable time after the specified time for completion, may allow further extension of time at its discretion with or without the levy of L.D. In the event of extension granted being with L.D, the Employer will be entitled without prejudice to any other right or remedy available in that behalf, to recover from the contractor as agreed damages equivalent to half per cent (½%) of the contract value of the works for each week or part of the week subject to the ceiling defined in sub-Clause 49 A. In the event of forfeiting the LD/EMD/SD performance guaranty and while imposing penalty GST at applicable rate is applicable.

49A(ii) The Employer, if not satisfied that the works can be completed by the contractor, and in the event of failure on the part of the contractor to complete work within further extension of time allowed as aforesaid, shall be entitled, without prejudice to any other right, or remedy available in that behalf, to rescind the contract.

49A(iii) The Employer, if not satisfied with the progress of the contract and in the event of failure of the contractor to recoup the delays in the mutually agreed time frame, shall be entitled to terminate the contract.

49A(iv) In the event of such termination of the contract as described in clauses 49A(ii) or 49A(iii) or both the Employer shall be entitled to recover L.D. up to ten per cent (10%) of the contract value and forfeit the security deposit made by the contractor besides getting the work completed by other means at the risk and cost of the contractor.

49A(v) In case Part / portions of the work can be commissioned and the Port operates the portion for commercial purposes, the rate of LD will be restricted to the uncompleted value of work, the maximum LD being on the entire contract value.

50. Nominated Subcontractors

All specialists, merchants, tradesmen and others executing any work or supplying any good, materials, Plant or services for which provisional Sums are included in the Contract, who may have been or be nominated or selected or approved by the Employer or the Engineer, and all persons to whom by virtue of the provisions of the Contract, the Contractor is required to subcontract shall, in the execution of such work or the supply of such goods, materials, Plant or services, be deemed to be subcontractors to the Contractor and are referred to in this Contract as "Nominated Subcontractors".

51. Advance payment (not applicable)

The Employer shall make the following advance payments:

- 51.1 Mobilization Advance shall be paid up to 10% of Contract price, payable in two equal installments. The first installment shall be paid after mobilization has started and next installment shall be paid after satisfactory utilisation of earlier advance.
- 51.2 Construction / installation equipment Advance shall be paid up to 5% of Contract price, limited to 90% of assessed cost of machinery.
- 51.3 Mobilization Advance and Construction Equipment Advance shall be paid at SBI PLR + 2% p.a. (as on date of payment) interest rate at the discretion of the employer and against Bank Guarantee for Mobilization Advance and against hypothecation of Construction Equipment to the Employer.
- 51.4 Equipment advance will be paid in two or more installments. First installment shall be paid after Construction Equipment has arrived at the site and next installment shall be paid after satisfactory utilization of earlier advance (s).
- 51.5 Recovery of Mobilization and Construction Equipment advance will start when 15% of the work is executed and recovery of total advance should be completed by the time 80% of the original Contract work is executed.
- 51.6 Secured Advance: The Engineer or his nominee shall make advance payment in respect of materials and plant brought to site but not yet incorporated and installed in the Works in accordance with conditions stipulated in the Contract Data.
75% of cost of materials and plant brought to site for incorporation into the works only shall be paid as Secured Advance. Materials which are of perishable nature should be adequately insured.

52. Securities

- 52.1 Security deposit shall consist of two parts
 - a) Performance security to be submitted at award of the work
 - b) Retention Money to be recovered from Running Bills.
- 52.2 The Security Deposit at 10% of the Contract amount including GST of which 5% of contract price should be submitted as Bank Guarantee within 21 days of receipt of letter of acceptance and balance 5% recovered as retention money from running bills. Recovery of 5% of retention money shall commence from the first RA bill onwards @ 10% for each bill. The retention money shall be refunded after completion of defect liability period. The performance Bank Guarantee will be released after completion of defect liability period.

53. Removal of Craft or Plant which has sunk (not applicable to this contract)

The Contractor shall forthwith and with dispatch at his own cost raise and remove any craft or plant (floating or otherwise) belonging to him or to any sub-contractor employed by him (including also any plant which is held by the Contractor or any sub-contractor under agreement for hire or hire-purchase) which may be sunk in the course of the construction completion or maintenance of the Works or otherwise deal with the same as the Engineer may direct or until the same shall be raised and removed, the contractor shall set al such buoys and display at night such lights and do all such things for the safety of navigation as may be required by the Engineer or by Employer. In the event of the Contractor not carrying out his obligation imposed upon him by this clause the Employer may provide buoy and light such sunken craft or plant and raise and remove the same (without prejudice to the right of the Employer to hold the Contractor liable under General Conditions) and the Contractor shall refund to the Employer all costs incurred in connection therewith.

Contractor's Temporary Moorings

Should the Contractor need, in connection with implementing the Works, to provide temporary moorings for his craft he may be allowed to do so in location and manner approved by the Engineer subject to all necessary permissions being first obtained by the Contractor from the authorities concerned. The Contractor shall not lay his temporary moorings such as to interfere with the port traffic and such moorings shall be removed if and when required by the Employer.

54. Cost of Repairs

53.1 Loss or damage to the Works or Materials to be incorporated in the Works between the Start Date and the end of the Defects Correction period shall be remedied by the Contractor at the Contractor's cost if the loss or damage arises from the Contractor's acts or omissions.

E. FINISHING THE CONTRACT**55. Completion**

After completion of the work, the contractor will serve a written notice to the Engineer or his nominee/Employer to this effect. The Engineer or his nominee/Employer upon receipt of this notice shall conduct a complete joint survey of the work within 7 days and prepare a defects list jointly. The defects pointed out by the Engineer or his nominee/Employer would be rectified by the contractor within 14 days and thereafter acceptance report be signed jointly by the contractor and the Employer. This joint acceptance report shall be treated as 'Completion Certificate'.

56. Taking Over

The Employer shall take over the Site and the Works within seven days of the Engineer or his nominee issuing a certificate of Completion.

57. Final Account

The Contractor shall supply to the Engineer or his nominee a detailed account of the total amount that the Contractor considers payable under the Contract before the end of the Defects Liability Period. The Engineer or his nominee shall issue a Defects Liability Certificate and certify any final payment that is due to the Contractor within 60 days of receiving the Contractor's account if it is correct and complete. If it is not, the Engineer or his nominee shall issue within 15 days a schedule that states the scope of the corrections or additions that are necessary for the correction and certify payment of 50% of the undisputed amount to the contractor. If the Final Account is still unsatisfactory after it has been resubmitted the Engineer or his nominee shall decide on the amount payable to the Contractor and issue a payment certificate, within 60 days of receiving the Contractor's revised account.

58. Submission of 'As built Drawings'

"As built" Drawings are required to be submitted by the Contractor and shall be supplied by them by the dates stated in the Contract Data. If the Contractor does not supply the Drawings and/or manuals by the dates stated in the Contract Data, or they do not receive the Engineer or his nominee's approval, the Engineer or his nominee shall withhold the amount stated in the Contract Data from payments due to the Contractor.

59. Termination

59.1 The Employer or the Contractor may terminate the Contract if the other party causes a fundamental breach of the Contract.

59.2 Fundamental breaches of Contract include, but shall not be limited to the following:

- (a) The Contractor stops work for 28 days when no stoppage of work

is shown on the current Program and the stoppage has not been authorized by the Engineer or his nominee.

- (b) The Engineer or his nominee instructs the Contractor to delay the progress of the Works and the instruction is not withdrawn within 28 days.
- (c) The Employer or the Contractor becomes bankrupt or goes into liquidation other than for a reconstruction restructure or amalgamation.
- (d) a payment certified by the Engineer or his nominee is not paid by the Employer to the Contractor within 50 days of the date of the Engineer or his nominee's certificate:
- (e) The Engineer or his nominee gives Notice that failure to correct a particular Defect is a fundamental breach of Contract and the Contractor fails to correct it within a reasonable period of time determined by the Engineer or his nominee.
- (f) The Contractor does not maintain a security which is required.
- (g) the Contractor has delayed the completion of works by the number days for which the maximum amount of liquidated damages can be paid as defined in the Contract data and
- (h) If the Contractor, in the judgment of the Employer has engaged in corrupt or fraudulent practices in competing for or in the executing the Contract.

For the purpose of this paragraph: "corrupt practice" means the offering, giving, receiving or soliciting of anything of value to influence the action of a public official in the procurement process or in contract execution. "Fraudulent practice" means a misrepresentation of facts in order to influence a procurement process or the execution of a contract to the detriment of the Employer, and includes collusive practice. Bidders (prior to or after bid submission) designed to establish bid prices at artificial non-competitive levels and to deprive the Employer of the benefits of free and open competition."

- 59.3 When either party to the Contract gives notice of a breach of contract to the Engineer or his nominee for a cause other than those listed under Sub Clause 59.2 above, the Engineer or his nominee shall decide whether the breach is fundamental or not.
- 59.4 Notwithstanding the above, the Employer may terminate the Contract for convenience subject to payment of compensation to the contractor including loss of profit on uncompleted works. Loss of profit shall be calculated on the same basis as adopted for calculation of

extra/additional items.

- 59.5 If the Contract is terminated the Contractor shall stop work immediately, make the Site safe and secure and leave the Site as soon as reasonably possible.

60. Payment upon Termination

- 60.1 If the Contract is terminated because of a fundamental breach of Contract by the Contractor, the Engineer or his nominee shall issue a certificate for the value of the work done less advance payments received up to the date of the issue of the certificate, less other recoveries due in terms of the contract, less taxes due to be deducted at source as per applicable law and less the percentage to apply to the work not completed as indicated in the Contract Data. Additional Liquidated Damages shall not apply. If the total amount due to the Employer exceeds any payment due to the Contractor, the difference shall be a debt payable to the Employer.

- 60.2 If the Contract is terminated at the Employer's convenience or because of a fundamental breach of Contract by the Employer, the Engineer or his nominee shall issue a certificate for the value of the work done, the reasonable cost of removal of Equipment repatriation of the Contractor's personnel employed solely on the Works, and the Contractor's costs of protecting and securing the Works and loss of profit on uncompleted works less advance payments received up to the date of the certificate, less other recoveries due in terms of the contract and less taxes due to be deducted at source as per applicable law.

61. Property

All materials on the Site, Plant, Equipment, Temporary Works and Works for which payment has been made to the contractor by the Employer, are deemed to be the property of the Employer, if the Contract is terminated because of a Contractor's default.

62. Release from Performance

If the Contract is frustrated by the outbreak of war or by other event entirely outside the control of either the Employer or the Contractor, the Engineer or his nominee shall certify that the Contract has been frustrated. The Contractor shall leave the Site and stop work as quickly as possible after receiving this certificate and shall be paid for all work carried out before receiving it and for any work carried out afterwards to which commitment was made.

F. SPECIAL CONDITIONS OF CONTRACT

The conditions of contract shall be the general conditions of contract in Section-III (v) as modified or added by the following condition of special conditions as provided in Section – III(vi) herein, which shall be read and construed with the general condition in Section – 3 A to E as if they were incorporated therein. In so far as any of the condition of the special conditions may conflict or be in consisting with any of general conditions of in Section -3F- Special condition of the contract shall prevail.

63. Labour

The Contractor shall, unless otherwise provided in the Contract, make his own arrangements for the engagement of all staff and labour, local or other, and for their payment, housing, feeding and transport.

The Contractor shall, if required by the Engineer or his nominee, deliver to the Engineer or his nominee a return in detail, in such form and at such intervals as the Engineer or his nominee may prescribe, showing the staff and the numbers of the several classes of labour from time to time employed by the Contractor on the Site and such other information as the Engineer or his nominee may require.

64. Compliance with labour regulations

During continuance of the contract, the Contractor and his sub-contractors shall abide at all times by all existing labour enactment and rules made there under, regulations, notifications and bye laws of the State or Central Government or local authority and any other labour law (including rules) regulations, bye laws that may be passed or notification that may be issued under any labour law in future either by the State or Central Government or the local authority. Salient features of some of the major labour laws that are applicable to construction industry are given below. The Contractor shall keep the Employer indemnified in case any action is taken against the Employer by the competent authority on account of contravention of any of the provisions of any Act or rules made there under, regulations or notifications including amendments. If the Employer is caused to pay or reimburse such amounts as may be necessary to cause or observe, or for non-observance of the provisions stipulated in the notifications/bye laws/Acts/Rules/regulations including amendments, if any, on the part of the Contractor the Engineer or his nominee/Employer shall have the right to deduct any money due to the Contractor including his amount of performance security. The Employer / Engineer or his nominee shall also have right to recover from the Contractor any sum required or estimated to be required for making good the loss or damage suffered by the Employer.

The employees of the Contractor and the Sub-Contractor in no case shall be treated as the employees of the Employer at any point of time.

65. Safety, Security and Protection of the Environment.

Subject and without prejudice to any other provision of the Contract, the Contractor shall take all reasonable precautions:

- (a) In connection with underground water resources (including percolating water) to prevent
 - (i) Any interference with the supply to or abstraction from such sources
 - (ii) Pollution of the water so as to affect adversely the quality thereof.
- (b) All works shall be carried out without unreasonable noise and disturbance. The Contractor shall indemnify the Employer from and against any liability for damages on account of noise or other disturbance created while or in carrying out the work and from and against all claims, demands, proceedings, damages, costs, charges and expenses whatsoever in regard or in relation to such liability.
- (c) The Contractor at his own cost shall make such provisions for lighting of Works, Temporary Works, Materials and Plant and shall provide all such marks and lights as may be required by the Employer or the Engineer or any other authority having jurisdiction over the Site together with all labour stores and services required for their efficient working and use at any time, day or night.

The Contractor shall also provide at his own cost every description of watching and maintenance required in connection with the foregoing, and all other services for protecting and securing all places dangerous whether to Contractor's workmen or to other persons until the Works are handed over to the Employer, or till such time when the Engineer decides that such services are no longer required.

All lights provided by the Contractor shall be placed or screened such as not to interfere with any navigation lights or with any traffic or signal lights of any local or other authority.

66. Insurance of Works and Contractor's Equipment

The Insurance shall be issued by Nationalized Insurance Company from its Mangalore Branch which has been determined by the Contractor to be acceptable to the Employer.

The contractor shall at his own costs and expenses obtain and shall cause any subcontractor to obtain such insurance as may be necessary to cover the liability of the contractor or as the case may be of such subcontractor in

respect of personal injuries and death arising out of or in the course of or caused during the execution of the works for a minimum amount of Rs. 25 lakhs and shall produce or cause any such subcontractor to produce for inspection the relevant policy or policies together with receipt for the premium paid under such policy/policies as and when required by the Employer.

- i. The Employer (NMPA) shall not be liable for any accident, damage or compensation payable to any workman or other person in the employment of the Contractor or any Subcontractor.
- ii. Employer Liability Insurance: The Contractor shall indemnify and keep indemnified the Employer i.e. NMPA against all damages or compensation payable at Law in respect of or in consequence of any accident or injury to any workman or other person in the employment of the Contractor or Sub-Contractor against all claims, demands, proceedings, costs, charges and expenses whatsoever in respect thereof or in relation thereto and the Employer shall be at liberty to deduct or adjust from the Contractor's bills an amount that Employer may be called upon to pay towards claims, demands, proceedings, costs, charges and expenses Whatsoever in respect of or in relation to any accident or injury referred to above without any reference to the Contractor.
- iii. The Contractor shall comply with all the Central State and Municipal Laws and Rules and shall be solely responsible for complying with the provisions of the Contract Labour (Regulations & Abolition) Act, 1970 & the contract labour (Regulation & Abolition) Karnataka Rules 1974 and rules there under and the enactments that may be applicable including ESI Act, the payment of wages act, Provident Fund Act, the Minimum Wages Act, the Factory's Act. The Workmen Compensation Act or any other applicable legislation and the Municipal by-laws or other statutory Rules and Regulations whatsoever in force if these are applicable. Any obligations finding or otherwise missed under any statutory enactments, rules & regulations there under shall be the responsibility of the Contractor and the NMPA will take no responsibility for the same. The Contractor should take Workmen's Compensation Policy for his Workers, who are not covered under ESI and submit the same to the EIC immediately after commencement of the work.
- iv. The Contractor is liable to pay all Statutory Compensation to the Labourers/persons engaged by him for the satisfactory execution of the works. If any claim is made against New Mangalore Port Authority on this work, the Port Authority shall have the right to deduct the same from the bill amount payable to the contractor after verification of the validity and if admissible as per rules.
- v. PERSONAL PROTECTIVE EQUIPMENTS The Contractor shall ensure the use of PPE such as helmets, safety shoes, nose masks, hand gloves, Safety Harness or any other equipment as required depending on nature of work by his staff at site.

67. War Risks Insurance

If the Contractor receives instructions from the Employer to insure against war risks, such insurance if normally available shall be effected, at the cost of the Employer, with the Insurance Company acceptable to the Employer and shall be in the joint names of the Employer and the Contractor.

68. Royalty

Except where otherwise stated, the contractor shall pay to the authority all tonnage and other royalties, rent and other payments or compensation if any, for getting stone, sand, gravel, clay or other materials by him and his subordinates and his subcontractors and required for the works, at the rates and such conditions as notified by the State Government. The applicable rates for royalty is enclosed as Schedule-A in Volume –III. The contractor should submit the Mineral Dispatch Permit (MDP) in original for the quantity executed by the contractor for the requisite quantity of material incorporated in works for which MDP is issued by the authorized supplier. If contractor fails to submit the MDP in original the amount equal to 5 times the royalty charges shall be deducted from the contractor's bills as per prevailing orders issued by the Authority.

69. Transport of Contractor's Equipment or Temporary Works

If it is found necessary for the Contractor to move one or more loads of heavy constructional plant or equipment materials or pre-constructed units or parts of units of work over roads, highways or bridges on which such oversized and over weight items are not normally allowed to be moved, the Contractor shall obtain prior permission from the concerned authorities. Payments for complying with the requirements, if any, for protection of or strengthening of the roads, highways or bridges shall be deemed to be included in his contract price.

70. Transport of Materials or Plant

The contractor shall save harmless and indemnify the Employer in respect of all claims, proceedings, damages, costs, charges and expenses whatsoever arising out of or in relation to any claim made by the concerned authorities in respect of damage or injury to roads, highways or bridges. In case of failure of the Contractor to settle such claims and in case the Employer is held responsible for payment to the authorities, then the Employer shall settle the claim and the Employer's expenses in this regard, as certified by the Engineer, may be deducted by the Employer from any money due or to become due to the Contractor and the Engineer shall notify the Contractor accordingly with a copy to the Employer.

71. Labor Laws & Regulations

The Contractor shall at all times during the continuance of the Contract comply fully with all existing Acts, regulations and bye-laws including all statutory amendments and re-enactment of State or Central Govt. and other local authorities and any other enactments and act that may be passed in future either by the State or the Central Govt. or local authority, including Indian Workmen's Compensation Act, Contract Labour (Regulation And Abolition) Act 1970 and Equal Remuneration Act 1976, Employees' State Insurance Act, 1948, Factories Act, Minimum Wages Act, Provident Fund Regulations. Employees' Provident Fund Act and schemes made under the same Act, Health and Sanitary Arrangements for Workmen, Insurance and other benefits and shall keep the Employer indemnified in case any action is commenced for contravention by the Contractor. If the Employer is caused to pay or reimburse any amounts as may be necessary to cause or observe, or for non-observance of the provisions stipulated here-forth on the part of the Contractor, the Engineer shall have the right to recover from the Contractor any sum required estimated to be required for making good the loss or damage suffered by the Employer. The Tenderers must have valid ESI and PF registration and shall maintain the records prescribed under ESI Regulations and PF Act & make the contribution towards ESI and PF in respect of persons employed by the Contractor. These contributions on the part of Employer paid by the contractor shall be reimbursed by the Engineer –in –charge to the contractor on actual basis. The contractor shall make available such records for inspection by ESI and PF authorities during inspection and furnish the copies of such records to the employer regularly. The EPF and ESI contribution on the part of the employer in respect of this contract shall be paid by the contractor. These contributions on the part of Employer paid by the contractor shall be reimbursed by the Engineer –in –charge to the contractor on actual basis. The minimum wages applicable for Mangalore City is enclosed as Schedule – B in Volume – III.

71.1. Accident Prevention/Safety Officer

The Contractor shall have on his staff on site an officer dealing with all matters regarding safety and protection against, accidents of all staff and labour. This officer shall be qualified for this work and shall have the authority to issue instructions and shall take protective measures to prevent accidents.

71.2 Disorderly Conduct

The Contractor shall at all times take all reasonable precautions to prevent any unlawful, riotous or disorderly conduct by or amongst his staff and labour and for the preservation of peace and protection of Persons and

property in the neighborhood of the Works from the same.

71.3 Health and Safety

Due precautions shall be taken by the Contractor, and at his own cost, to ensure the safety of his staff and labour and, in collaboration with and to the requirements of the local health authorities, to ensure that medical staff, first aid equipment and stores, sick bay and suitable ambulance services are available at the camps, housing and on the site at all times throughout the period of the Contract and that suitable arrangements are made for the prevention of epidemics and for all necessary welfare and hygiene requirements.

71.4 Supply of Water

The Contractor shall, so far as is reasonably practicable, having regard to local conditions provide on the Site, to the satisfaction of the Engineer's Representative, an adequate supply of drinking and other water for the use of the Contractor's staff and work people.

71.5 Alcoholic Liquor or Drugs

The Contractor shall not, otherwise than in accordance with the Statutes, Ordinances and Government Regulations or Orders for the time being in force, import, sell, give, barter or otherwise dispose of any alcoholic liquor, or drugs or permit or suffer any such importation, sale, and gift, barter disposal by his sub-contractions agents or employees.

71.6 Arms and Ammunition

The Contractor shall not give, barter or otherwise dispose of to any persons or person, any arms or ammunition of any kind or permit or suffer the same as aforesaid.

71.7 Festivals and Religious Customs

The Contractor shall in all dealings with labour in his employment have due regard to all recognized festivals, days of rest and religious or other customs.

71.8 Epidemics

In the event of any outbreak of illness of an epidemic nature, the Contractor shall comply with and carry out such regulations, orders and requirements as may be made by the Govt., or the local medical or sanitary authorities for the purpose of dealing with and overcoming the same.

71.9 Employment of Person in the Service of Others

The Contractor shall not recruit or attempt to recruit his staff and labour from amongst persons in the service of the Employer or other agencies engaged for any works of the Employer.

71.10 Housing for Labour

Save in so far as the Contract otherwise provides, the Contractor shall provide and maintain such accommodation and amenities as he may consider necessary for all his staff and labour employed for the purposes of or in connection with the Contract, including all fencing water supply (both for drinking and other purposes), electricity supply, sanitation, cook houses fire prevention and fire-fighting equipment, **crèche for children** of his staff and labour employed for the purposes, furniture other requirements in connection with such accommodation or amenities. On completion of the Contract, unless otherwise agreed with the Employer, the temporary camps/housing provided by the Contractor shall be removed and the site reinstated to its original condition, all to the approval of the Engineer. The land for construction of labour camps shall be allotted outside the security area to the extent available and such area allotted for labour camps will be charged a ground rent at TAMP approved rates depending upon the location. The ground rent is liable for change as per the prevailing TAMP rates from time to time during the currency of the contract.

71.11 Fair Wages, Records, Inspection

The Contractor shall pay the labourers engaged by him on the work not less than a fair wage which expression shall mean whether for time or piecework the respective rates of wages as fixed by the Public Works Department as fair wages for Dakshina Kannada District payable to the different categories of labourers of those notified under the Minimum Wages Act.

The Contractor shall maintain records of Wages and other remuneration paid to his employee in such form as may be convenient and to the requirements of the Employer/Engineer and the Labour Enforcement Officer (Central), Ministry of Labour, Govt. of India, or such other authorized person appointed by the Central Govt. The Contractor shall allow inspection of the aforesaid Wage Records and Wage Slips to the Engineer and to any of his workers or to his agent at a convenient time and place after due notice is received, or to any other person authorized by him on his behalf.

71.12 Reporting of Accidents

The Contractor shall report to the Engineer details of any accident as soon as possible after its occurrence. In the case of any fatality or serious accident, the Contractor shall, in addition, notify the local police authorities immediately by the available means.

71.13 Observance by Sub-Contractors

The Contractor shall be responsible for observance by his sub-contractors of the foregoing provisions.

71.14 Port Entry Permission(Not applicable to this contract)

The Contractor shall submit prior application for Port entry passes to the concerned Port authority for his Materials, labours and the staffs engaged in the works. The Contractor has to get the vehicle and labour RIFD based passes for the entry inside the wharf area based on prevailing rates.

71.15 Site - Protected Area (Not applicable to this contract)

The Site of Work is a protected area. Entry to the Port premises is regulated by entry passes. These passes will be issued by the Central Industrial Security Force or any other authority authorized by the Employer. The Contractor should furnish a list of person for whom the passes are to be issued to the Engineer and arrange to obtain the passes from the appropriate authority, based on the recommendation of the Engineer and abide by the Rules of the New Mangalore Port Authority with regard to entry etc. For the entry of trucks and other vehicles also, the Contractor should obtain necessary permits.

The Contractor shall retain the original passes obtained by them in respect of their labour and staffs engaged in the Works and produce the same to the Engineer as and when called for. It should not be either destroyed or allowed to be taken by the labour/staff after its use.

The entry and exit of construction equipment, Plants, construction materials etc., into the Port premises is also regulated by Gate passes. These gate passes will be issued by the Engineer and the Contractor shall produce the same at the security Gate during the entry and exit of the materials. The duplicate copy of the inward pass shall be retained by the Contractor and shall be produced at the Gate during the exit of the materials along with the outward gate pass.

72. Life Saving Appliances and First Aid

The Contractor shall provide and maintain upon the Works sufficient proper and efficient lifesaving appliances and first aid equipment to the approval of the Engineer. The appliances and equipment shall be available for use at all times.

73. Diving Operations (Not Applicable)

- a) Any diving work shall be carried out in accordance with the Diving Operations Regulations of the Government of India.
- b) Before any diving work is undertaken the Contractor shall supply the Engineer or his representative with two copies of the Code of signals to

be employed and is to have a copy of such Code Prominently displayed on the craft or structure from which the operations take place

74. Bribes

If the Contractor, or any of his Subcontractors, agents or servants gives or offers to give to any person any bribe, gift, gratuity or commission as an inducement or reward for doing or forbearing to do any action in relation to the Contract or any other contract with the Employer, or for showing or forbearing to show favour or disfavor to any person in relation to the Contract or to any other contract with the Employer, then the Employer may enter upon the Site and the works and terminate the employment of the Contractor and the provisions of Clause 63 hereof shall apply as if such entry and termination had been made pursuant to that Clause.

The bidders shall give an undertaking that they have not made any payment or illegal gratification to any person/authority connected with the bid process so as to influence the bid process and have not committed any offence under the PC Act in connection with the bid.

The bidders shall disclose any payments made or proposed to be made to any intermediaries (agents etc) in connection with the bid.

75. Details to be Confidential

The Contractor shall treat the details of the contract as private and confidential, save insofar as may be necessary for the purposes thereof, and shall not publish or disclose the same or any particulars thereof in any trade or technical paper or elsewhere without the previous consent in writing of the employer. If any dispute arises as to the necessity of any publication or disclosure for the purpose of the Contract the same shall be referred to the decision of the Employer whose award shall be final.

76. Contractor's Temporary works, office, etc.

76.1 The Contractor shall submit to the Engineer for his approval not less than 15 days before commencement of erection of any part of Temporary Works, drawings and detailed proposals for the method of construction of Temporary works such as office, store, false work and temporary platforms etc. which he intends to construct for the execution of the contract and no such work shall be constructed before obtaining the written approval of Chief Engineer. These temporary works, office, store etc. shall be erected at or near the work area subject to approval of the Employer and the land space for the same will be allotted free of ground rent to the extent available. The Contractor shall obtain permission for any Temporary Works and would ensure that during execution of

works the statutory requirements of the concerned authorities such as New Mangalore Port Authority, Police, Customs, etc. would be complied with.

76.2 Submission of Reports, Returns, etc.

All reports, statements, returns, drawings, diagrams etc. which the Contractor is required to submit to the Engineer during the progress of the Works, shall be furnished in triplicate without any additional cost.

77. Water Supply

Water to the extent available will be supplied to the Contractor at a fixed point on the main water supply line within the Port area. The plumbing connection and extension of necessary supply pipeline to the working area shall be arranged by the Contractor at his own cost. The Contractor shall also provide a water meter at his cost for metering the quantity of water used. Charges for the consumption of the water will be paid by the Contractor to the Employer at the prevailing rate notified time to time during the currency of the Contract. For non-supply of water at any stage port will not be responsible and the Contractor shall not have any claim whatever for loss or damage.

78. Power Supply

The Electricity connection for lighting, welding and other mechanical works to the extent available will be made available by the Employer within the Port area. Drawing of power lines etc. from the available point of supply of power to the actual work site either by overhead lines or underground cables shall be arranged by the contractor at his cost. The temporary lines and connections by the Contractor shall be approved by the Engineer's representative before availing power. The Contractor shall provide Trivector Meter to read consumption in units, power demand and power factor.

The Contractor shall indicate his requirement of power to the Engineer within 15 days from the date of the letter of acceptance of the tender. If the power requirement is more than 50 KW, the Contractor has to avail the power supply at 11 KV and install his own transformer of suitable capacity and work carried out as per IE Rules & Regulations as approved by the CEA. The Contractor shall pay to the Employer, the power charges as per the prevailing Tariff schedule of MESCOM in force during the work of the Contractor with applicable demand charges and security deposit along with departmental charges @ 23.75% of the bill amount. The Contractor shall also pay the connection and disconnection charges as applicable.

The Contractor shall ensure that the power factor of the system does not fall below 0.90 at any time and shall provide at his cost required capacity capacitors bank to maintain the Power Factor of all power loads. If the capacity of the capacitor found less than stipulated as per regulation during inspection, surcharge at Rs. 0.03 per unit will be levied. The contractor shall pay refundable Security Deposit before availing the power supply.

The Contractor shall submit a complete drawing of the power points, wiring, diagram indicating all electrical loads, earthing etc. in complete shape along with the completion report. The Trivector Meter provided is calibrated either by M/s. MESCOM or NITK, Surathkal, and such a Certificate to be produced. For non supply of power at any stage port will not be responsible and the Contractor shall not have any claim whatever for loss or damage.

79. Taxes and Duties

79.1 The Contractor shall pay tax if any, and other levies as applicable from time to time. GST at applicable rate shall be shown separate line items in the tax invoice.

79.2 Sales / Turnover Tax on Works Contract (**DELETED**)

79.3 Income Tax

The Contractor and his staff shall be responsible for payment of all personal income taxes to the concerned authorities as per the law in force from time to time. Deduction of Income Tax shall be made by the Employer from each certificate of payment to the contractor at the rate of 2% plus surcharge or such other rates as may be specified by the Central Government from time to time, on the gross amount of the Contractor's bill for payment.

79.4 Goods and Service Tax

The contractor shall not include GST component in rate. The GST shall be paid to the contractor separately as applicable. The contractor shall submit running account bills indicating GST separately as applicable. The Contractor shall be responsible for the payment of GST applicable, to the GST authority.

80. Price Adjustment (not applicable to this contract)

The following clause shall be read in continuation to clause no. 47 of GCC. The sanction towards the compensation for escalation or deduction on account of de-escalation and the amount thus sanctioned will be included in the next running account bill or final bill as the case may be. The cost of work for which escalation/de-escalation is applicable / deductible shall be worked out as per cl. 32.8.6.1., CPWD works manual, 2003.

The cost of work for which escalation/de-escalation is applicable / deductible shall be worked out as below:

- (a) Gross value of work done up to this quarter (A)
 - (b) Gross value of work done up to the last quarter (B)
 - (c) Gross value of work done since previous quarter (a) – (b) (C)
 - (d) Full assessed value of SA fresh paid in this quarter (D)
 - (e) Full assessed value of SA recovered in this quarter (E)
 - (f) Full assessed value of SA for which escalation is payable in this quarter (d) – (e) (F)
 - (g) Advance payment made during the quarter (G)
 - (h) Advance payment recovered during the quarter (H)
 - (i) Advance payment for which escalation is payable in this quarter (g)– (h) (I)
 - (j) EI paid based on prevailing M/R during the quarter (J)
- $$X = C \pm F \pm I - J$$
- $$Y = 0.85 X$$
- (k) Less cost of materials supplied by the department & recovered during the quarter (K)
 - (l) Less cost of services tendered at fixed charges & recovered during the quarter (L)
 - (m) Cost of work for which escalation/de-escalation is applicable $W=Y - (K + L)$

81. Noise and Disturbance

All works shall be carried out without unreasonable noise and disturbance. The Contractor shall indemnify the Employer from and against any liability for damages on account of noise or other disturbance created while or in carrying out the work and from and against all claims demands proceedings damages costs charges and expenses whatsoever in regard or in relation to such liability.

82. Safety Code

Necessary Indian Safety regulations for the safety purpose shall be adhered to by the contractor and he will be held responsible for any violations of the same. The set of such conditions (regulation) is available with NMPA and the contractor is required to go through it before tendering.

Besides the above, the Contractor shall also scrupulously adhere to and observe the following safety codes:

The Contractor has to provide sufficient barricades to site of work so that traffic plying nearby should not damage the recently concreted work. In case of any damage on account of above, the entire responsibility will remain with contractor and nothing extra will be paid on this account.

Suitable and strong scaffolds should be provided for the workmen for all work that cannot be safely done from ground. No portable single ladder shall be over 8 meters in length.

Hoisting machines and tackles used in the works including their attachments, and supports shall be in perfect condition as per stipulations of the relevant Rules. The ropes used for hoisting or lowering materials or as means or suspension shall be of durable quality and adequate strength and free from defects.

The excavated material shall not be placed within 1.5 meters of the edge of the trench or half of the depth of the trench, whichever is more. All trenches and excavation shall be provided with necessary fencing to lighting. Every opening in the floor of a building or in a working platform shall be provided with suitable fence to prevent the fall of persons or materials. No floor, roof or other parts of the structure shall be so overloaded with debris or materials as to render it unsafe.

Workers employed on mixing and handling materials such as cement, cement mortar, concrete, lime mortar and asphalt shall be provided with protective footwear and rubber hand gloves and thin cloth for covering face and head.

Those engaged in welding work shall be provided with welder protective eye shield and glove.

All safety rules shall be strictly followed while working on live electrical systems or installations as stipulated in the relevant Rules.

83. Port Authority Rules

The Contractor shall observe the Conservancy Rules relating to the harbour and shall always take such necessary additional steps to keep the harbour waters free of noxious or unhygienic matters coming from his works as are required by the Employer. Under no circumstances shall inflammable materials be allowed to spill into the harbour waters.

The Contractor shall always observe and comply with the working rules and regulations of the Port Authority in force or as issued from time to time.

84. Execution of work

The contractor shall be required to execute the work in such a way so as not to cause any damage, hindrance or interference with port activities going on in the area or nearby. He should not also deposit the materials at such places which may cause inconvenience to the public and the work going on in the nearby area. The Contractor shall have to make good all damages done by him to the structures nearby while executing the work and no extra payment shall be made to him on that account.

All the materials required to be used in the work shall have to be got approved from the Engineer-in-Charge before stacking at the site of work. Barricading, including proper lighting arrangement in the night at the required places shall

have to be provided by the contractor at his own cost, including necessary arrangements for proper movement of traffic by carefully maintained approaches and road diversions with suitable sign boards for indications of road signs etc. as directed by the Engineer-in-Charge.

Details of every consignment of materials delivered to site shall be provided to the engineer – in – charge and brought to his notice in advance. The materials shall be used for consumption only after the approval of the engineer – in – charge. The brand of materials along with relevant test certificates shall be submitted for approval prior to commencement of work. No change in brand is permitted for reasons whatsoever.

85. Customs Duty

Being Port Development Project, Customs Duty shall be applicable as per project import chapter 9801.00 read with Notification 17-2001, serial No. 38 (vi) and Notification 42-96 amended by 21-2000 of customs tariff, Government of India.

Customs Duty leviable shall be paid directly by the Contractor to the Customs Authorities, Government of India. The Employer shall reimburse this amount upon submission of documentary evidence in original for the proof of payment of such Customs Duty. The reimbursement of such amount towards Customs Duty shall be limited to the Ceiling amount quoted by the Contractor in the Bill of Quantities as above. If the Contractor incurs Customs Duty Levy less than the said Ceiling Amount, the reimbursement by the Employer shall be limited to the documented cost of Customs Duty levies actually paid to the Customs Authorities, Government of India. If the Actual Customs Duty levies paid by the Contractor exceeds the said Ceiling Amount, then the reimbursement by the Employer shall be limited to the Ceiling Amount. The reimbursement of the Customs Duty will be limited only to the Imported Materials listed in “Preamble and Bill of Quantities”, BOQ No. __. During the execution of the Works, if it necessitates for expeditious completion of the Works, Contractor may resort to import of any of the materials not listed aforesaid, with the approval of the Employer. However, the aggregate amount of Customs Duty to be reimbursed shall not exceed the lump sum amount offered in the Priced Bill of Quantities.

It shall be the responsibility of the Contractor to provide the requisite particulars and documents to the customs and other Government authorities and get the Imported Materials cleared and transported in time. The Contractor shall be fully responsible for port and Customs clearance including stevedoring, handling, unloading, loading, storage, inland transportation, if any of materials, equipments and plant to storage godowns, yards, sites etc.

The contractor shall be fully responsible for any delays, penalties charges and losses if any in this regard.

The Employer shall upon request from the Contractor along with necessary details, provide recommendatory letter(s) for Imported Materials at concession rate or Customs Duty as applicable. However, the responsibility for obtaining such concession rate of customs duty shall be that of the Contractor.

It shall be the responsibility of the Contractor to check the latest position on Customs duty levies applicable and the Employer does not accept any liability on the account. For bill of Lading, the "Consignee" for permanent materials to be incorporated into the Works will be the New Mangalore Port Authority. The Contractor will be "Notify Party". Notwithstanding the above, obtaining "Essentiality Certificate" (if any), payment of deposit (if any) towards Customs Duty, etc. shall be the responsibility of the Contractor.

The Contractor shall give an undertaking follows:

- a) Being the ultimate Employer of the materials to be imported and incorporated into the works covered under the Tender _____ we request New Mangalore Port Authority to be consignee in the matter of permanent materials to be imported by us at our cost (covering payments of materials by letter of credit) including freight, insurances, taxes and any other charges whatsoever payable in connection with the import and its incorporation into the work.
- b) We hereby confirm, in the event of New Mangalore Port Authority becoming consignee, it will not absolve us from any of the obligations, and will not alter the payment terms under the Contract No. SCB II/ 2009 dated between (*the Contractor*) and New Mangalore Port Authority.
- c) New Mangalore Port Authority becoming a consignee is a matter of convenience and we undertake to abide by all the obligations, responsibilities etc. as if we are our self a consignee.
- d) In respect of nay consequences arising out of New Mangalore Port Authority becoming the consignee we hereby unequivocally and irrevocably agree to indemnify New Mangalore Port Authority for such consequences.
- e) We also undertake and confirm to obtained all permits and licenses etc. at our own cost. New Mangalore Port Authority's responsibilities in this regard will be the same as under the said contract and limited to issuing required recommendatory letters for obtaining such permits and licenses.

f) *This undertaking does not in anyway vitiate our contractual liabilities and obligations cast upon us by Contract No. SCB II/ 2009 dated between(the Contractor) and New Mangalore Port Authority.*

86. Drawings & Designs (Not applicable to this contract)

- (a) General details of the works are shown on the drawings accompanying this tender document. The Engineer will supply to the Contractor from time to time during the progress of the works such further working drawings as will be necessary in his opinion for the proper and adequate execution and maintenance of the Works in accordance with the Engineer's designs and/or any modification thereof as decided by the Engineer and the Contractor shall carry out the work in accordance with the said working drawings. Two sets of such working drawings will be issued. If the Contractor requires more sets he will have to make his own arrangement at his cost. Residual Design, Detailing & Engineering: - The Engineer to the project has done the detailed design and engineering for the subject tender. During execution of the work the residual design, detailing and engineering, if needed, is to be carried out by the contractor at no extra cost to the Employer. For equipment/ Installations detailed drawings need to be produced by the contractor at no extra cost to the Employer. The contractor shall also get approved such design, detailing & engineering from the Engineer.
- (b) In the event of the Contractor proposing any alteration/modification to the Engineer's design, detail, method of construction, he shall at his own expenses prepare and submit for approval of the Engineer copies in duplicate (in the first instance) of detailed working drawings which may be required for such alteration/modification and at the same time call the attention of the Engineer to any alternative detail or modification of the contract drawings which the Contractor may wish to make at least 30 days prior to the commencement of the work or part of the work to which such drawings relate. The contractor shall at the same time, if so required by the Engineer, furnish calculation sheets in duplicate relating to the strength and anticipated deflections in respect of such altered/modified works. The Engineer will, after any such alteration which he may approve, record on the copies as amended his approval and will return one copy of the drawings and calculation sheets to the contractor, who shall carryout the work in accordance therewith. The contractor shall forward to the Engineer three additional copies of the working drawings and calculation sheets as approved in additions to these working drawings and calculation sheets as approved. In addition to these working drawings are also to be submitted (the same procedure as in the

ease of the contractor) in respect of any work proposed to be executed by sub-contractors. The approval of the Engineer of all or any of the calculation sheets, drawings shall not relieve the contractor of responsibility in connection with the execution of the altered/modified or subcontractor's work.

(c) Submission of 'As built Drawings'

"As built" Drawings are required to be submitted by the Contractor and shall be supplied by them by the dates stated in the Contract Data. If the Contractor does not supply the Drawings and/or manuals by the dates stated in the Contract Data, or they do not receive the Engineer or his nominee's approval, the Engineer or his nominee shall withhold the amount stated in the Contract Data from payments due to the Contractor.

87. Monsoon Period

Monsoon period will be reckoned from 1st June to 30th September.

88. Progress Report

The following reports shall be submitted for review; as an input to the Management meeting to be held as per Clause No 31 of Conditions of Contract.

88.1 Daily reports

The contractor shall submit daily report indicating daily activities, weather condition, actual manpower, equipment and the prominent materials available and arriving to site. The contractor shall submit the daily report format to the Department for prior approval.

88.2 Monthly Reports

Monthly progress reports shall be prepared by the Contractor and submitted to the Engineer in triplicate. The first report shall cover the period up to the end of the first calendar month following the Commencement Date. Reports shall be submitted monthly thereafter, each within 7days after the last day of the period to which it relates. Reporting shall continue until the Contractor has completed all work, which is known to be outstanding at the completion date, stated in the Taking-Over Certificate for the Works.

Each report shall include:

Charts and detailed descriptions of progress, including each stage of design (if any), Contractor's Documents, procurement, manufacture, delivery to Site, construction, erection and testing; and including these stages for work by each Sub-Contractor,

Photographs in hardcopy & digital copy and videography in two sets showing the various stages of progress on the Site monthly;

For the supply of manufactured items, the name of the manufacturer,

manufacture location, percentage progress, and the actual or expected dates of:
 Commencement of manufacture,
 Contractor's/Engineer's inspections,
 Tests,
 Shipment and arrival at the Site;
 Copies of quality assurance documents, test results and certificates of Materials;
 Safety statistics, including details of any hazardous incidents and activities relating to environmental aspects and public relations; and
 Comparisons of actual and planned progress, with details of any events or circumstances which may jeopardize the completion In accordance with the Contract, and the measures being (or to be) adopted to overcome delays.

89. Completion Documents

To treat that the work has been completed and issue a final payment certificate, the following documents will be deemed to form the completion documents:

- i. The Technical documents according to which the work was carried out.
- ii. Certificates of final levels and dimensions as set out for various works.
- iii. Certificates of tests performed for various works.

90. Facilities / Services to be provided at the site (Not Applicable)

After the issue of Engineer's notice to commence, the Contractor shall as soon as possible, make available of the following facilities for the staff of the Engineer at the Site of Work, all to the approval of the Engineer or his Representative and the Contract Price shall be deemed to be inclusive of the provision for these facilities:

Provide and maintain, throughout the period of Contract, one no of Office accommodation at site office / Porta cabin measuring not less than 4m x 5m. each, with electricity and water supply and adequate ventilation for the sole use of Engineer's Representative, his staff.

Provide and maintain suitable furniture for the office, including: Tables with two lockable drawers and chairs, Almirah with shelves and necessary electrical fittings.

Provide and maintain, throughout the period of Contract, a Toilet along with washroom facilities with electricity and water supply and adequate ventilation for the sole use of Engineer's Representative, his staff.

Desk top Computers of latest configuration with printers and all other necessary accessories, internet and loaded with the latest version of software like M.S. Office, AutoCAD etc. with windows operating system.

One photocopying machine capable of Black & White copying / Scanning A4 & A3 size of paper, with auto feed of papers (Source to be copied) along with

sorting facilities.

The contractor shall make available during the currency of contract all the Survey instruments and various measuring devices necessary for the execution of the project.

A lock and four (4) keys for the office room. There shall be no spare keys in the possession of any person other than Engineer's Representative.

91. Payments

The Clause No. 43 payments shall be replaced as follows

- i. The Contractor has to submit the bill within 7 days of joint measurement taken along with the concerned Engineer. The Engineer has to ensure that joint measurement to be completed within 7 days of completing of part work / running work. The concerned Engineer i/c shall check and make entries into bill/M.B within 10 days of submission of the interim bill and submit to Executive Engineer/ Superintending Engineer (Civil). The Executive Engineer/ Superintending Engineer (Civil) shall check the bills and after certification of the quantities as per manual shall forward to the Finance Department within 3 working days. The Contractor and Assistant Engineer both jointly complete the measurements, if Contractor due to any reason does not attend/avoid joint survey/measurements the Executive Engineer shall give notice to the contractor to be present at the site for joint measurement within 7 days' notice. If the contractor fails to attend the joint measurement second notice shall be issued to the contractor to attend the joint measurement within 3 days failure to attend the site for joint measurement the Assistant Engineer and AEE or EE would record the reason and complete the measurements in a transparent manner departmentally and submit the bill. Bills shall be prepared and submitted by the Contractor. Joint measurements shall be taken continuously and need not be connected with billing stage. System of 4 copies of measurements, one each for Contractor, Employer and Engineer or his nominee, and signed by both Contractor and Employer shall be followed.
- ii. Interim of bill amount will be paid within 14 days of submission of the bill.
- iii. Contractor shall submit final Bill within 60 days from the date of completion of work and the same will be paid by the Port within 30 days from the date of submission
- iv. The payment will be made to the contractor after deducting any dues payable to the Port statutory authorities etc
- v. If an amount certified is increased in a later certificate as a result of an award by the DRB or an Arbitrator, the Contractor shall be paid interest upon the delayed payment as set out in this clause. Interest shall be

calculated from the date upon which the increased amount would have been certified in the absence of dispute.

- vi. Items of the Works for which no rate or price has been entered in will not be paid for by the Employer and shall be deemed covered by other rates and prices in the Contract.

92. Retention

The Clause No. 48 Retention shall be replaced as follows

The Employer shall retain from each payment due to the Contractor the proportion stated in the Contract Data until Completion of the whole of the Works.

Retention Money shall be deducted at 10% from Running Bills subject to a max. of 5% of the contract price plus Goods Service tax applicable. Retention money shall be refunded after issue of No defects certificate.

93. Submission of statutory documents

The successful bidder, within 7 days from the date of work order, shall submit self-attested copy of statutory documents such PAN card, GST registration certificate, ESI registration certificate, EPF registration certificate, Labour Identification Number (LIN) and any other documents required for successful completion of work.

G. SALIENT FEATURES OF SOME MAJOR LAWS APPLICABLE TO ESTABLISHMENTS ENGAGED IN CONSTRUCTION WORK

- (a) Workmen Compensation Act 1923:- The Act provides for compensation in case of injury by accident arising out of and during the course of employment.
- b) Payment of Gratuity Act 1972: Gratuity is payable to an employee under the Act on satisfaction of certain conditions on separation if an employee has completed 5 years service or more on death at the rate of 15 days wages for every completed year of service. The Act is applicable to all establishments employing 10 or more employees.
- (c) Employees P.F and Miscellaneous Provision Act 1952: The Act Provides for monthly contributions by the employer and workers @ 13.61% and 12% respectively. The benefits payable under the Act are:
 - (i) Pension to family pension on retirement or death, as the case may be.
 - (ii) Deposit linked insurance on the death in harness of the worker.
 - (iii) Payment of P.F accumulation on retirement/death etc.
- d) Maternity Benefit Act 1951:-The Act provides for leave and some other benefits to workmen/ employees in case of confinement or miscarriage etc.
- e) Contract Labour (Regulation & Abolition) Act 1970:-The Act provides for certain welfare measures to be provided by the Contractor to contract labour and in case the Contractor fails to provide, the same are required to be provided, by the Principal Employer by Law. The Principal Employer is required to- take Certificate of Registration and the Contractor is required to take license from the designated Officer. The Act is applicable to the establishments or Contractor of Principal Employer if they employ 20 or more contract labor.
- f) Minimum Wages Act 1948: The Employer is supposed to pay not less than the Minimum Wages fixed by appropriate Government as per provisions of the Act if the employment is a scheduled employment Construction of Buildings, Roads, Runways are scheduled employment.
- (g) Payment of Wages Act 1936:-It lays down as to by what date the wages are to be paid when it will be paid and what deductions can be made from the wages of the workers.
- (h) Equal Remuneration Act 1979:-The Act provides for payment of equal wages for work of equal nature to Male and Female workers and for not making discrimination against Female employees in the matters of transfers, training and promotions etc.
- i) Payment of Bonus Act 1965: The Act is applicable to all establishments employing 20 or more employees. The Act provides for payments of annual bonus subject to a minimum of 8.33% of wages and maximum of 20% of wages to employees

drawing Rs. 3500/- per month or less. The bonus to be paid to employees getting Rs. 2500/- per month or above up to Rs. 3500/- per month shall be worked out by taking wages as Rs. 2500/- per month only. The Act does not apply to certain establishments. The newly set-up establishments are exempted for five years in certain circumstances. Some of the State Governments have reduced the employment size from 20 to 10 for the purpose of applicability of this Act.

- j) Inter-State Migrant workmen's (Regulation of Employment & Conditions of Service) Act 1979: The Act is applicable to an establishment which employs 5 or more inter-state migrant workmen through an intermediary (who has recruited workmen in one state for employment in the establishment situated in another state). The Inter-State migrant workmen, in establishment to which this Act becomes applicable, are required to be provided certain facilities such as housing, medical aid, travelling expenses from home upon the establishment and back,
- k) The Building and Other Construction workers (Regulation of Employment and Conditions of Service) Act 1996 and the Cess Act of 1996:- All the establishments who carry on any building or other construction work and employ 10 or more workers are covered under this Act. All such establishments are required to pay cess at the rate not exceeding 2% of the cost of construction as may be modified by the Government. The Employer of the establishment is required to provide safety measures at the Building or Construction work and other welfare measures, such as Canteens, First-Aid facilities, Ambulance, Housing accommodations for workers near the work place etc. The Employer to whom the Act applies has to obtain a registration certificate from the Registering Officer appointed by the Government.

v) CONTRACT DATA

Items marked "N/A" do not apply in this Contract.

Sl. No.	Description	Reference Cl. No.
1	The following documents are also part of the Contract	
	The Schedule of other contractors	(8)
	The Schedule of Key personnel	(9)
2	The above insertions should correspond to the information provided in the Invitation of Bids.	
3	The Employer is	(1)
	New Mangalore Port Authority, Panambur, Mangalore – 575010	
	Name of Authorized Representative:	
	Name : Chairman, New Mangalore Port Authority, Panambur, Mangalore – 575010	
4	The Engineer is	
	Name : Chief Engineer (C), New Mangalore Port Authority, Panambur, Mangalore- 57501010	
	Name of Nominee is	
	Name : Superintending Engineer (CI) Civil Engineering Department, NMPA, Panambur, Mangalore- 575010	
5	The name and identification number of the Contract is	
	Name of Contract :- "Development of Garden adjacent to Godown No:31 and 32 at NMP" Tender no: CIVIL/DyCE(C)/EE(C)/83/2024-25	(1)
6	The works consist of Development of Garden adjacent to Godown No:31 and 32 at NMP.	(1)

Sl. No.	Description	Reference Cl. No.		
7	The start date shall be 15 days from the date of Issue of Letter of Acceptance. However the work shall be commenced only after signing contract agreement	Conditions of contract A-General 1.Definitions		
8	The Contract Price is the price stated in the letter of acceptance and thereafter as adjusted in accordance with the provisions of the Contract. However payment will be made as per actual work done accordance with the contract provisions.	1.Definitions		
9	The Intended completion Date for the whole of the Work is 1 (One) Months including monsoon with the following milestones:	(17,28)		
10	<p>Milestone dates:</p> <table border="1" data-bbox="375 821 1170 936"> <tr> <td data-bbox="375 821 773 936">Physical works to be completed</td> <td data-bbox="773 821 1170 936">Period from the date of commencement of work</td> </tr> </table> <p>Milestones dates shall be provided to the Contractor by the Executive Engineer executing the work ,for completion of the work as per the scheduled date.</p>	Physical works to be completed	Period from the date of commencement of work	
Physical works to be completed	Period from the date of commencement of work			
11	<p>The following shall form part of the Contract Document:</p> <ol style="list-style-type: none"> (1) Form of Agreement (2) Letter of Acceptance (3) Contractor's Bid (4) Contract Data (5) Conditions of Contract including Special Conditions of Contract (6) Specifications (7) Drawings (8) Bill of quantities and (9) Any other documents listed in the Contract Data as forming part of the Contract. (10) Correspondence exchanged after the opening of the Bid and before the issue of Letter of Acceptance by which the Condition of Contract are amended, varied or modified in any way by mutual consent (to be enumerated). 	(2.3)		
12	The Contractor shall submit a Program for the Works within	(27)		

Sl. No.	Description	Reference Cl. No.
	14 days of delivery of the letter of Acceptance.	
13	The site possession date The site will be handed over immediately after issue of Letter of acceptance and the site is free from encumbrances.	(21)
14	The site is located at Panambur in NMP area and is defined in drawing No. 2025/1205/Mtc-I/01-LP	
15	The Defects Liability Period is 1 (One) year.	(35)
16	The minimum insurance cover for physical property, injury and death is Rs. 5,00,000/- (Rupees five Lakhs) per occurrence with the number of occurrences limited to four. After each occurrence, contractor will pay additional premium necessary to make insurance valid for four occurrences always.	(13)
17	The following events shall also be Compensation Events: The Employer terminates the contract for his convenience.	(44)
18	The period between Programme updates shall be 30 days.	(27)
19	The amount to be withheld for late submission of an updated Programme shall be Rs. 25,000/-.	(27)
20	The Penalty for the delay in submission of the Performance guarantee shall be at the rate of 0.25% of the amount of performance guarantee for each week or part of the week for the number of weeks delayed beyond the stipulated date of submission.	(52.2) 34.1
21	The language of the Contract documents is English.	(3)
22	The law, which applies to the Contract, is the law of Union of India.	(3)
23	The currency of the Contract is Indian Rupees.	(46)
24	Fees and types of reimbursable expenses to be paid to the Dispute Review Board as per actual and equally shared by both the parties.	(25)
25	The Dispute Review Board shall be constituted after signing of the agreement on mutually agreed terms.(Appendix 1). (Not applicable to this contract)	(25)
26	Price Adjustment (deleted)	(47) (80)
27	The proportion of payments retained (retention money) shall be 10% of total tax invoice value from each running bill	(48)

Sl. No.	Description	Reference Cl. No.
	subject to a maximum of 5% of the contract price (Contract price including GST) as applicable.	
28	The maximum amount of liquidated damages for the whole of the works is 10 % of the contract price plus taxes and duties. The half per cent (½%) per week L.D is applicable for delay period of $\frac{1}{3}$ of contract period and thereafter 10% L.D is applicable.	[49]
29	Clause No. 49A (v) deleted.	
30	Advance payment is not applicable to this contract	[51]
31	Repayment of secured advance: deleted	(51.6)
32	The Securities shall be for the following minimum amounts equivalent as a percentage of the Contract Price.	(52)
33	Performance Security in the form of Bank guarantee for 5% of contract price (Contract price including GST)	(52.2)
34	The standard form of Performance Security acceptable to the Employer shall be an unconditional Bank Guarantee of the type as presented in Section III (iv) of the Bidding Documents.	Annexure-A

vi) FORM OF SECURITIES

Acceptable forms of securities are annexed. Bidders should not complete the Performance Security form at this time. Only the successful Bidder will be required to provide Performance and Advance Payment Securities in accordance with one of the forms, or in a similar form acceptable to the Employer.

Annexure A: Performance Bank Guarantee

Annexure B: Bank Guarantee for Advance Payment (not applicable)

Annexure A

PERFORMANCE BANK GUARANTEE

To: _____ [name of Employer]
_____ [address of Employer]

WHEREAS _____ [name and address of Contractor] (hereinafter called "the Contractor") has undertaken, in pursuance of Contract _____ No. _____ dated _____ to execute _____ [name of Contract and brief description of Works] (hereinafter called "the Contract").

AND WHEREAS it has been stipulated by you in the said Contract that the Contractor shall furnish you with a Bank Guarantee by a recognized bank for the sum specified therein as security for compliance with his obligations in accordance with the Contract;

AND WHEREAS we have agreed to give the Contractor such a Bank Guarantee;

NOW THEREFORE we hereby affirm that we are the Guarantor and responsible to you, on behalf of the Contractor, up to a total of _____ [amount of guarantee]1

_____ [In words], such sum being payable in the types and proportions of currencies in which the Contract Price is payable, and we undertake to pay you, upon your first written demand, and without cavil or argument, any sum or sums within the limits of _____ [amount of guarantee]1 as aforesaid without your needing to prove or to show grounds or reasons for your demand for the sum specified therein.

We hereby waive the necessity of your demanding the said debt from the Contractor before presenting us with the demand.

We further agree that no change or addition to or other modification of the terms of the Contract or of the Works to be performed there under or of any of the Contract documents which may be made between you and the Contractor shall in any way release us from any liability under this guarantee, and we hereby waive notice of any such change, addition or modification.

This guarantee shall be valid until 28 days from the date of expiry of the Defects Liability Period.

Notwithstanding anything mentioned above,

Our liability against this guarantee is restricted to Rs..... (Rupees only) and unless a claim in writing is lodged with us within 3 months of the date of expiry or the extended date of expiry of this guarantee all our liabilities under this guarantee shall stand discharges.

IN WITNESS WHEREOF this guarantee has been duly executed on this day of

.....

Signature and seal of the guarantor _____

Name of Bank _____

Address _____ Date _____

1 An amount shall be inserted by the Guarantor, representing the percentage of the Contract Price specified in the Contract and denominated in Indian Rupees.



NEW MANGALORE PORT AUTHORITY
Panambur, Mangalore

“DEVELOPMENT OF GARDEN ADJACENT TO GODOWN
NO:31 AND 32 AT NMP”

TENDER DOCUMENT
Volume - II

NEW MANGALORE PORT AUTHORITY
CIVIL ENGINEERING DEPARTMENT

Tender no: CIVIL/CE(C)/EE(C)/83/2024-25

Tender for

“Development of Garden adjacent to Godown No:31 and 32 at NMP”

<u>Volume I</u>	Section I	i) Notice Inviting Tenders i) Instructions to Tenderers ii) Annexure (1 to 8)
	Section II	i) Form of Agreement
	Section III	i) Conditions of Contract: Part A - E: General Conditions ii) Conditions of Contract : Part F: Special Conditions iii) Contract Data iv) Form of Securities (A & B) v) Appendix – I and Appendix - II
<u>Volume II</u>	Section IV	i) Technical Specifications
	Section V	ii) Drawings
<u>Volume III</u>	Section VI	i) Preamble ii) Bill of Quantities iii) For of tender
	Section VII	i) Schedules (A & B)

Table of Contents

TECHNICAL SPECIFICATIONS	117
A. GENERAL.....	117
1. INTRODUCTION	117
B. WORKS	121
1. Supply of JCB.....	121
2. Supply of tipper:-	121
3. Providing and Fixing the G.I pipe.....	121
4. Providing and fixing of shade net green	121
5. Supply of red earth	121
6. Supply and planting of Royal Palm.....	121
7. Supply and planting of Eugenia Red plant	121
8. Supply and planting of Saflora plant.....	121
9. Supply and laying the PVC pipe of 20cm dia	122
SECTION V	122
DRAWINGS	122

SECTION IV

TECHNICAL SPECIFICATIONS

A. GENERAL

1. INTRODUCTION

The intent of this technical specification covers construction of all civil works as covered in the scope of contract as per drawings supplied by Owner.

All civil works shall be carried out as per design / drawings standardized by the Consultant / Owner and the specification provided by the Consultant / Owner. All standard drawings are enclosed with the tender documents. In case any item is not covered under specification then the same shall be carried out as per CPWD specification and applicable Standards and Codes. Any item for which specification is not provided herein and is not covered under CPWD specification shall be executed as per manufacturer guidelines. All materials shall be of best quality conforming to relevant Standards and Codes. In case of any conflict between Standards / Code and Technical Specification, the provisions of Technical Specification shall prevail, and the Engineer's decision on interpretation shall be final.

The Contractor shall furnish all labor, tools, equipment, materials, temporary works, constructional plant and machinery, fuel supply, transportation and all other incidental items not shown or specified but as may be required for complete performance of the Works in accordance with drawings, specifications and direction of Owner.

Excavated earth is to be disposed from site as instructed, only into approved landfill areas and dump yard. The cost of excavation to include for necessary lead and lift as specified.

All materials including cement, reinforcement steel and structural steel etc. shall be arranged by the Contractor. All testing required shall be arranged by the Contractor at his own cost. The contractor shall execute the work as per the standard Field Quality Plan (FQP) of NMPT.

The bidder shall fully apprise himself of the prevailing conditions at the proposed site, climatic conditions including monsoon patterns, local conditions and site specific parameters and shall include for all such conditions and contingent measures in the bid, including those which may not have been specifically brought out in the specifications.

Level and date of concreting shall be marked on the building from outside at every floor level with proper paint, etc.

All levels and survey work shall be measured by total station and electronic level machine at all floors and places.

Brief Description of Works

The scope of work is defined in the Notice Inviting Tender. The Contractor shall provide all necessary materials, equipment and labour etc. for the execution and maintenance of the work till completion.

The work shall be executed in accordance with the specification stipulated in the Bill of Quantity and other bidding documents read along with CPWD (Central Public Works Department) specifications for civil works and IS codes with up-to-date revisions. For non-schedule items specification as given along with tender document and similar items of CPWD shall be applicable.

The list of references for civil works are CPWD specifications, relevant IS codes and best practices.

For deep excavations, necessary shoring is to be done, the design of which will be provided by the contractor, after assessing site and soil conditions, and work only to be commenced on site after the same is duly approved by NMPT. Any approval if required from the Mineral department or any other statutory body that has jurisdiction on such excavations has to be obtained by the contractor.

All earth used for back filling should be of approved quality.

For ready mixed cement concrete, in addition to the CPWD specification, the following also to be noted:

The cost towards cement quantity reduced from the specified quantity in the item due to mixing of fly ash shall be deducted as per relevant BOQ item. The design mix shall be submitted to Engineer in Charge for approval.

All hard ware fittings shall be of best quality and shall be selected as per the Instructions of Engineer in Charge.

All paints shall be of best quality, approved by the Engineer in Charge shall be used.

Site location, Boundaries and Possession

The location and boundaries of the Site are shown on the Drawing No: **2025/1205/Mtc-I/01-LP**. The Contractor shall confine his activities strictly to the allotted site area(s) and shall not allow his personnel to trespass upon any other areas occupied by the Employer.

1.4 Site Datum and Base Lines

A base line shall be established within the working area by the Contractor. The base line shall be referenced to the site co-ordinate system (based on the Local Coordinates of New

Mangalore Port). This bench mark and base line will be the basis for the setting-out for all the Works. The main levels and lines for each portion of the Works shall be established from the bench mark and base line by the Contractor.

1.5 Site Conditions

1.5.1 Location of Work

As per enclosed location plan.

1.5.2 Climate

The climate at Mangalore is tropical with high humidity and a maximum shade temperature of 36°C. The average annual rainfall is approximately 3330 mm and concentrated in the south-west monsoon months of June, July, August and September during which period the average rainfall is as much as 82% of the total annual rainfall.

1.5.3 Wind

The wind in the monsoon months of June, July and August are predominantly from south-west and west with a maximum intensity of 5 on the Beaufort Scale. The winds in the remaining months of the year are predominantly from the north-west and the maximum intensity during this period is also of 5 on the Beaufort Scale.

1.5.4 Cyclones

Even though Mangalore is within the cyclonic area of storms originating in the Arabian Sea and those that enter across the Indian Peninsula from Bay of Bengal, cyclones are not as severe or frequent as in the Bay of Bengal. The maximum wind speed so far recorded in cyclonic storm, generally does not exceed 62 kmph (16.9 m/sec.) except one during 1965 when the maximum speed recorded was 97 kmph (26.9 m/sec.)

1.5.5 Visibility

Thirty year period observations conducted by the Indian Meteorological Department reveal that poor visibility (visibility less than 4 Kms) is encountered for about 10 days in the south-west monsoon period. The maximum number of foggy days in a year is only 3.

1.5.6 Site Preparation

The Contractor shall furnish all necessary supervision, labour, materials, equipment and tools for Site Preparation, clearing and all other works. Clearing shall mean to completely demolish, remove and dispose with all leads, lifts and descents from the area marked, trees, bushes, deadfalls, embedded logs, dislodged roots, stumps, snogs, boulders, mounds, existing structures and other objectionable materials. The areas required to be cleared shall

consist of the work Site, ditches, borrow pits, diversions and all other areas necessary for the construction work as directed by the Engineer-in-Charge.

Before any Temporary Works are commenced, the Contractor shall submit his proposal along with complete drawings of all Temporary Work, he may require for the execution of the Works in advance to the Engineer for approval. The Contractor shall also submit his calculations relating to the design of temporary works, strength, etc. if required by the Engineer and shall carry out the modifications that the Engineer may require of such temporary works at Contractor's own cost. The Contractor shall be solely responsible for the stability and safety of all Temporary Work.

It will be the responsibility of the Contractor to make timely procurement of all materials and mobilize all essential equipment for both Temporary and Permanent Works.

1.6 Site Information

The detailed drawing . [2025/1205/Mtc-I/01-](#) of the construction site for adaptation of methodology for the construction. However, on account of this change in the geographical profile of site, no extra cost for additional arrangement required to be made will be paid for.

1.7 The Nature of Soil Profile

The site comprises of ordinary soil. The details furnished herein are only for the information/guidelines of the tenderers and the successful contractor shall not claim for any deviation in the actual subsoil profile encountered at site.

1.8 Records

Complete records of all operations connected with the work shall be kept by the Contractor. The Contractor shall submit to the Engineer-in-charge for approval his proposal of the manner of presentation of these records. Three copies of all such records shall be furnished to the Engineer-in-charge on completion of each test or operation.

B. WORKS

1. Supply of JCB

Supply of JCB for leveling and clearing the debries/ soil including cost and conveyance of all materials, labours, driver, tools etc., complete..

2. Supply of tipper:-

Supply of tipper to load and dump the unwanted materials as directed by the Engineer with in 5KM lead, including cost and conveyance of all materials, labours, driver, tools etc., complete.

3. Providing and Fixing the G.I pipe

Providing and Fixing the G.I pipe of dia 40mm of length 2.00m founded in M15 grade cement concrete (45cmx45cmx45cm), 0.6 metre below ground level, including cost and conveyance of all labour, materials etc., complete as per the direction of Engineer.

4. Providing **and fixing of shade net green**

Providing and fixing of shade net green in colour made of 100% virgin HDPE, with light weight messed Polyethylene fabric. Including G.I wire in 4 rows, cost and conveyance of all materials, labours, transportation, fixing etc, complete. as directed by the department.

5. **Supply of red earth**

Supply of red earth of approved quality from the approved quarry including loading and unloading, cost of labour, T&P and all other incidental charges etc. complete as directed by the dept.

6. **Supply and planting of Royal Palm**

Supply and planting of Royal Palm including earth work excavation, Manuring, soil filling, cost and conveyance of all materials, labours etc., complete.

7. **Supply and planting of Eugenia Red plant**

Supply and planting of Eugenia Red plant at 0.30m c/c including earth work excavation, manuring, watering, cost and conveyance of all materials, labours etc., complete.

8. **Supply and planting of Saflora plant**

Supply and planting of Saflora plant at 0.30m c/c including earth work excavation, manuring, watering, cost and conveyance of all materials, labours etc., complete.

9. Supply and laying the PVC pipe of 20cm dia

Supply and laying the PVC pipe of 20cm dia for sprinkling system including fixtures and sprinkler at 5m intervals, cost and conveyance of all materials, labour etc., complete.

Note : During the Defect Liability period the contractor has to maintain the Garden with watering/Manuring/Cutting Hedges for One year with required two labours.

SECTION V

DRAWINGS

Brief Description of drawing

The Works are shown in the following drawings that are issued as a part of the Tender Documents:

Sl. No	Drawing No.	Description
1	2025/1205/Mtc-I/01-LP	LOCATION PLAN
2	2025/1205/Mtc-I/02-LP	LAYOUT PLAN

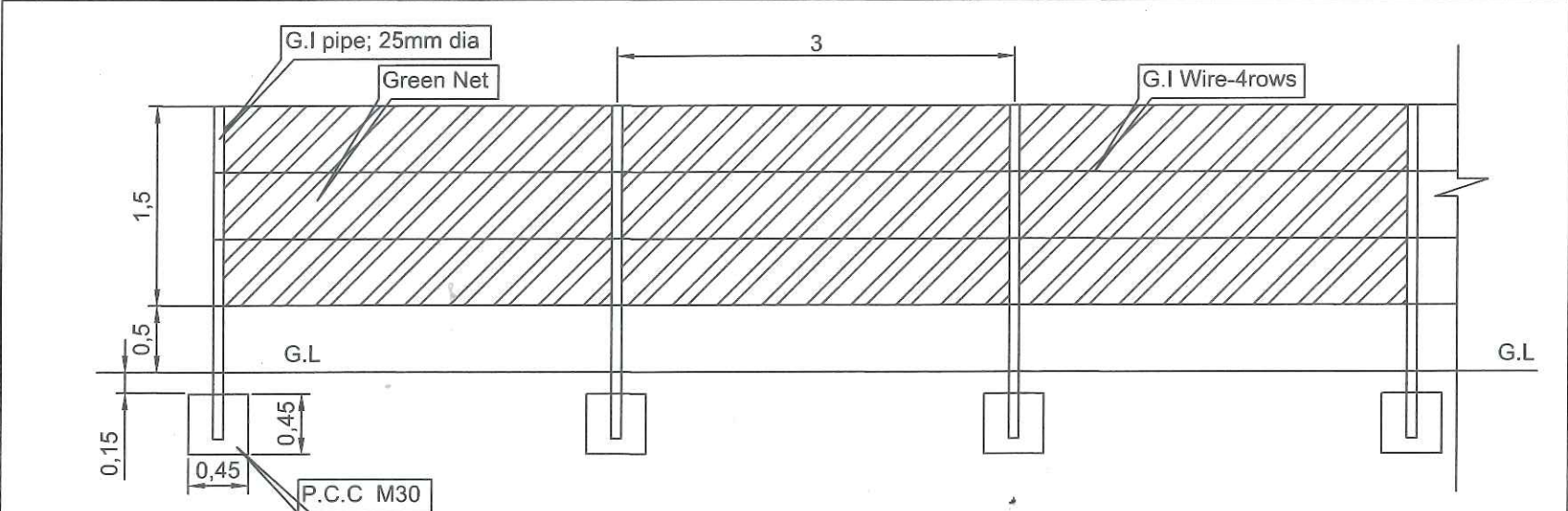

Details green net barricade

details of plant around Fox tail palm

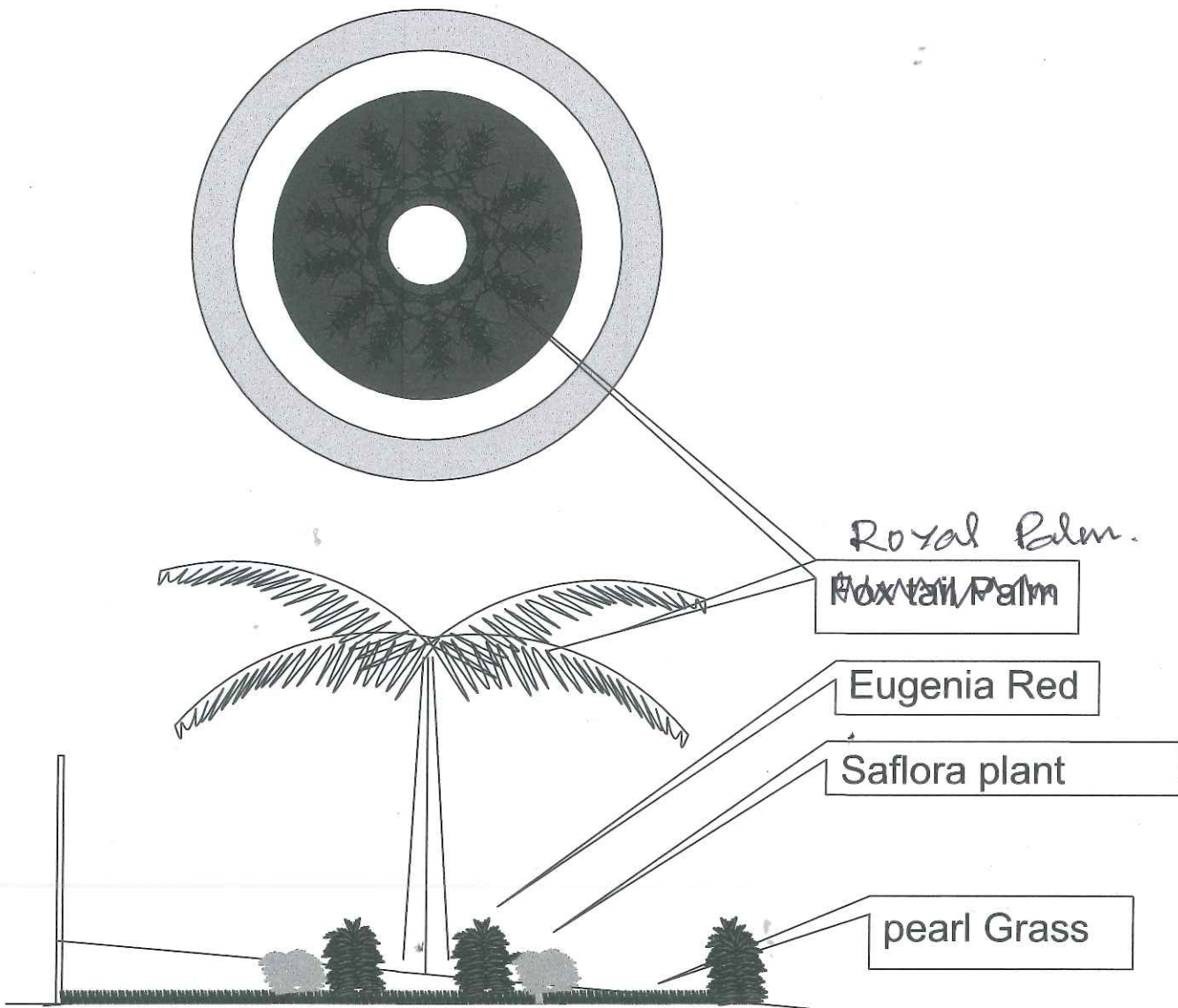

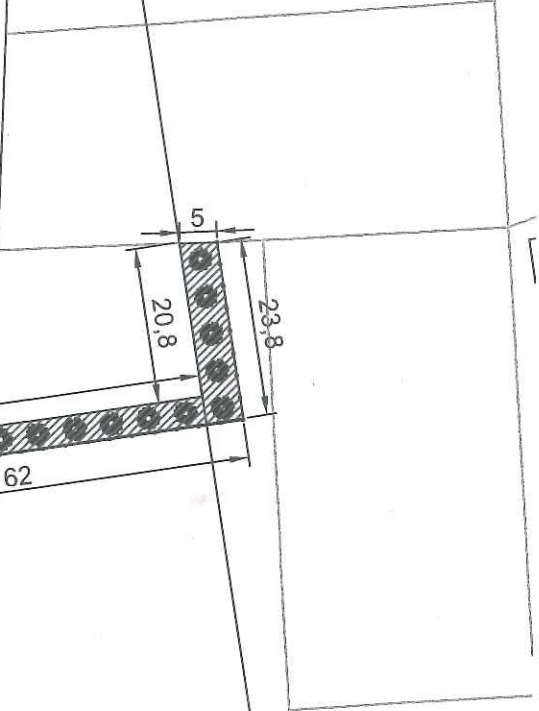
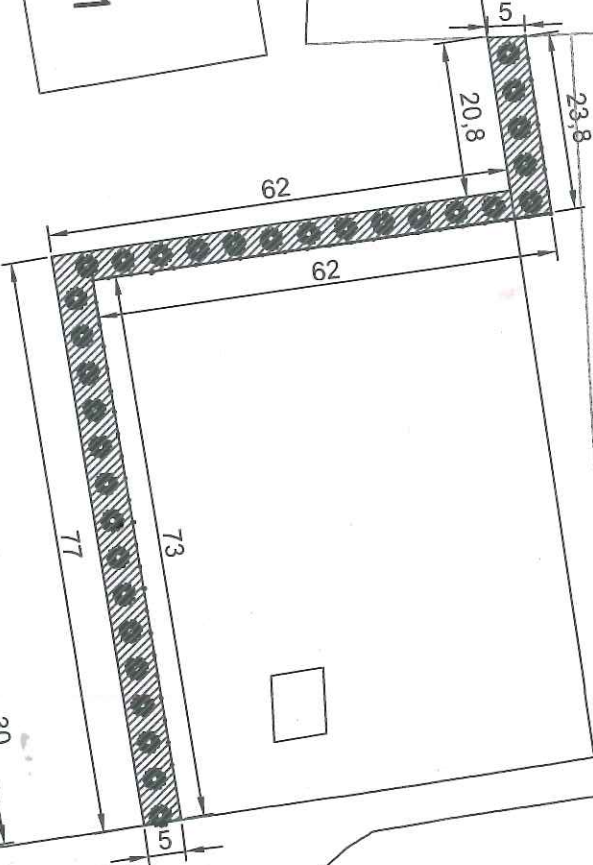
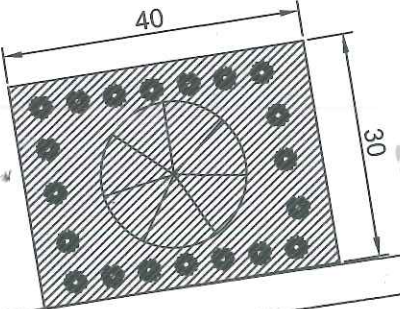
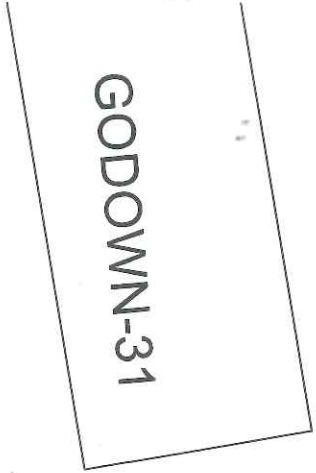
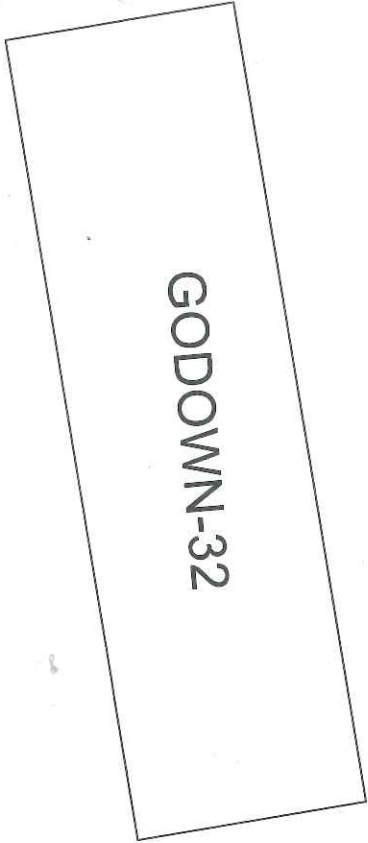
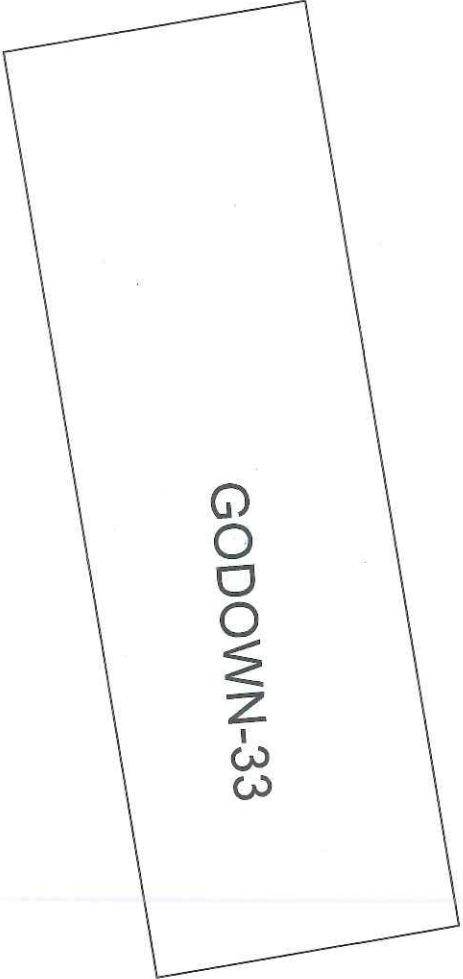



NEW MANGALORE PORT TRUST
Panambur, Mangalore

“Development of Garden adjacent to Godown No:31 and 32 at
NMP

TENDER DOCUMENT
Volume - III

BILL OF QUANTITIES

Table of Contents

SECTION VI	128
(i) PREAMBLE TO BILL OF QUANTITIES	128
1. General Instructions.....	128
2. Civil Works.....	132
3. Abbreviations.....	134
ii) BILL OF QUANTITIES.....	136
(iii) FORM OF TENDER.....	138
 SECTION VII	 140
SCHEDULE – A.....	140
ROYALTY	140
SCHEDULE – B.....	146

VOLUME III**SECTION VI****(i) PREAMBLE TO BILL OF QUANTITIES****1. General Instructions****1.1 General**

1.1.1 This Bill of Quantities must be read with the Drawings, Conditions of Contract and the Specifications, and the Contractor shall be deemed to have examined the Drawings, Specifications, Conditions of Contract and to have acquainted himself with the detailed descriptions of the Works to be done, and the way in which they are to be carried out.

1.1.2 Notwithstanding that the work has been sectionalized every part of it shall be deemed to be supplementary to and complementary of every other part and shall be read with it or into it so far as it may practicable to do so.

1.1.3 The detailed descriptions of work and materials given in the Specifications are not necessarily being repeated in the Bill of Quantities.

1.1.4 The Contractor shall be deemed to have visited the Site before preparing his tender and to have examined for himself the conditions under which the work will proceed and all other matters affecting the carrying out of the works and cost thereof.

1.1.5 The Tenderer will be held to have familiarised himself with all local conditions, in so far as they affect the work, means of access and the locality of existing services, in order to execute the Works measured and described hereinafter. No claims for want of knowledge in this respect will be reimbursed.

1.2 Rates and Prices to be Inclusive

- 1.2.1 Rates and prices set against items are to be the all inclusive value of the finished work shown on the Drawings and/or described in the Specification or which can reasonably be inferred there from and are to cover the cost of provision of plant, labour, supervision, materials, test charges, freight, transportation, erection, installation, performance of work, care of works, insurance, maintenance, overheads and profits and every incidental and contingent cost and charges whatsoever including taxes if any excluding GST including every kind of temporary work executed or used in connection therewith (except those items in respect of which provision has been separately made in the general condition of contract) and all the Contractor's obligations under the Contract and all matters and things necessary for the proper completion and maintenance of the Works.
- 1.2.2 The rates and prices set down against the items are to be the full inclusive value of the finished work shown on the Drawing and/or described in the Specification or which can reasonably be inferred the reform and to cover the cost of every description of Temporary Works executed or used in connection therewith (except those items in respect of which specific provision has been separately made in these Bills of Quantities) and all the Contractor's obligations under the Contract including testing, giving samples and all matters and things necessary for the proper execution, completion and maintenance of the Works.
- 1.2.3 The Specifications are intended to cover the supply of material and the execution of all work necessary to complete the works. Should there be any details of construction or material which have not been referred to in the Specifications or in the Bill of Quantities and Drawings, but the necessity for which may reasonably be implied or inferred there from, or which are usual or essential to the completion of all works in all trades, the same shall be deemed to be included in the rates and prices entered in the Bill of Quantities. The rates and prices are to cover the item as described in the Bill of Quantities and if there is inconsistency in the description between the Bill of Quantities, Specifications or Drawings, the interpretation

will be done according to General Conditions of Contract.

- 1.2.4 The quantities given in the Bill are approximate and are given to provide a common basis for tendering. They are not to be taken as a guarantee that the quantities scheduled will be carried out or required or that they will not be exceeded. The Employer / Engineer reserves the right to delete any item and / or increase / reduce quantities indicated in the Bills of Quantities at any time. Payment will be made according to the actual quantities of work ordered and carried out in the contract. However, the rates quoted shall be valid for any extent of variation in quantity of each individual item provided that the total contract value does not get altered by more than indicated in conditions of contract. No claim whatsoever for extra payment due to variation of quantities within the above said limit would be entertained.
- 1.2.5 The drawings for tender purposes are indicative only of the work to be carried out. However, the Tenderer must allow within his price for the items of work included in the Tender Documents for the details which will appear on subsequent drawings developed for construction purposes. Rate and price shall include any additional design/ detailing to be carried out by contractor.
- 1.2.6 The rates and prices shall include (except where separate items are given) for the provision and operation of the following items, for compliance with the Conditions of Contract, Special Conditions, the specifications and Tender drawings:
- i) Supervision and labour for the Works;
 - ii) All materials, installation/erection, handling and transportation;
 - iii) All Contractor's Equipment;
 - iv) All testing, commissioning, insurance, maintenance, security, welfare facilities, overheads and profit and every incidental and contingent costs and charges whatsoever including;
 - v) All temporary fencing, watching, lighting, sanitary accommodation, general security arrangements,

- welfare facilities and first aid provision;
- vi) Provision and maintenance of Contractor's site offices, cabins, huts, maintenance and storage areas;
- vii) Taxes if on the transfer of property in goods in the execution of works, other than GST, Customs Duty for materials to be permanently incorporated into the Works);
- viii) All necessary temporary services including fresh water, compressed air lines, electrical cabling and switchgear, telephone, walkie-talkie and facsimile facilities;
- ix) The maintenance of all Contractor's services;
- x) All insurances for the Works;
- xi) Allowance for complying with all environmental aspects as specified;
- xii) Detail design of components of temporary works, wherever necessary as directed by Engineer.

1.4 Method of Measurement

1.4.1 Measurement of Work shall be in accordance with IS 1200 and shall be net off the dimensions of the works shown on the drawings except as mentioned below:

1.4.2 Units of Measurement: The units of measurement used in this Bill of Quantities are in metric units as follows:

- i) Linear: Linear metre, centimeter or millimeter abbreviated to 'Rm', 'cm' or 'mm' respectively.
- ii) Superficial: Square metre or Square centimeter abbreviated to 'Sq.M' or 'sq.cm' respectively.
- iii) Volumetric: Cubic metre abbreviated to 'cu.m'. Litre abbreviated to 'L'
- iv) Weight: Tonne = 1000 Kilograms, abbreviated to 'T', / 'MT' Kilogram abbreviated to 'kg'
- v) Numbers: Numbers abbreviated to Nos. or No.
- vi) Lump sum: Lump sum abbreviated to 'L.S.'

1.5 Currency

1.5.1 All monetary reference herein and the Bill of Quantities shall be priced in Indian Rupee Currency.

2. Civil Works

2.2 Precast Concrete

- 2.2.1 Shuttering for precast concrete shall not be measured and paid for separately.
- 2.2.2 Effort for placement of precast concrete at the final locations shall not be measured unless a specific item is provided in the Bill of Quantities.
- 2.2.3 The precast concrete units shall be measured as shown on the detailed drawings.

2.3 In-situ Concrete

- 2.3.1 Shuttering for In-situ concrete shall not be measured and paid for separately.
- 2.3.2 No deduction will be made for chamfers smaller than 50 sq.cm. sectional area, reinforcement bolts and other embedded parts unless larger than 0.1 sq.m. sectional area and 0.03 cu.m. in volume. No extra volume will be measured for splays or fillets smaller than 50 sq.cm. sectional area.
- 2.3.3 The rates for reinforced concrete shall include for all batching, mixing, transporting, hoisting or lowering to any height / depth, placing in position and compaction in work of any sectional area or thickness including shuttering, forming necessary construction joints, shear keys and stop ends, and for curing and protecting etc. all as specified.
- 2.3.4 The rates shall include for preparing construction joints, shear keys and surfaces against which next stage concrete is to be cast and building in fittings including pipes and bolts except where specifically billed separately. No separate payment will be made for making openings/pockets/pits of any size and shape. Where surfaces are to receive finishes the rates shall include for leaving the surface rough or for hacking and roughening the surface to form a key.
- 2.3.5 Unless otherwise noted, rates shall include for inserting pipes

and other inserts in position accurately, concreting while they are in position and also for protecting the same as the work proceeds.

2.3.6 Unless otherwise noted, the rates for concrete items shall include for finishing the top surface to levels and slopes and surface finish as specified. Rates for concrete shall include for finishing the slab to specified slope towards drains, etc.

2.4 Reinforcement

2.4.1 Steel reinforcement will be measured by weight and fixed in accordance with Drawings and Specifications. The weight of reinforcement bars -whether plain, deformed or ribbed etc., -of various diameters will be calculated in accordance with Table 1 of IS:1732 'Dimensions for Round and Square Steel Bars for Structural and General Engineering Purposes'.

2.4.2 The rates shall include for cutting, weldinglaps, and waste, straightening short and long lengths, bending, fixing, rolling margin and the provision of spacer bars or support, chairs, binding wire, saddles, forks and all dense concrete spacer blocks, etc., including preparing bending schedules from the Drawings.

2.4.3 The rates shall include for all necessary descaling, wire brushing and cleaning to remove all rust and mill scale, dirt, grease and other deleterious matter before fixing and whilst still exposed during construction.

2.5 Structural and Miscellaneous Steel work

2.5.1 Rates for structural steel work and iron work shall include supply, fabrication, delivery and erection/embedment in concrete at Site and all charges for welding, cutting, bending, bolting, site connections, fixing to foundations.

2.5.2 The rates for Structural Steelwork shall include:

- i) Supply, fabrication, delivery and erection
- ii) Rolling margin, cutting and waste, weld metal, bolts, fixings and fittings
- iii) Hoisting, drilling, bolting or welding and fixing in the manner specified or indicated in the drawing
- iv) Fabrication drawings

- v) Welding trials and tests
- vi) Erection trials
- vii) Protective treatment (painting, hot dip galvanizing etc), including making good any damage if provided in the BOQ item.

2.5.3 Metalwork items are described in the Bills of Quantities and the Tenderer is to include for all the fittings, etc., described. All items shall include the necessary fabrication, joints, angles, intersections and ends, all bolts or fixing lugs, all hoisting and scaffolding required and casting in fixings or later cutting out or forming pockets for same, grouting, supporting and making good.

2.5.4 Rates are to include for all necessary scaffolding, working over water and at any height staging and hoisting and tarpaulin or other protective covers and the cleaning and removal of paint stains and spots, etc.

3.4.1 The Contractor's unit rates and prices shall include all equipment, apparatus, material indicated in the Drawings, and/or Specifications in connection with the item in question and also associated labour as well as all additional equipment, apparatus, material, consumables usually necessary to complete the system even though not specifically shown, described or otherwise referred to and also associated labour.

3.4.2 The rate for providing and fixing above items shall include all fittings, fixtures, base and sole plates, anchor bolts, including epoxy grouting, etc. all complete as specified, including the necessary additional supervision to ensure accurate alignment

3. Abbreviations

4.1.1 The following abbreviations are used in the Specifications and Bill of Quantities:

IS :	Indian Standard
BS :	British Standard
Qty. :	Quantity
mm :	Millimeters
cm :	Centimeters
M / m / MTR /Rmt	Meters
LM :	linear metre

LS :	lump sum
Rs. :	Rupees
P. :	Paise
Nos. :	Numbers
do :	Ditto
MS :	mild steel
T :	Tones
Kg :	Kilogram
EO :	Extra over (previous sum unless specified otherwise)
sq.m. /m ² /SQMT:	square metre
sq.cm. :	square centimeters
mm ² :	Square Millimetre
Cu.m/CUM. :	cubic meters
YST :	yield stress
dia :	Diameter
wt. :	Weight
Drg.No.:	drawing number
max. :	Maximum
min :	Minimum
approx :	Approximately
n.e.:	not exceeding
incl:	Including
circ:	Circular
set :	set / sets
c/c	centre to centre
@ :	at the rate of
Ope :	Operation

ii) BILL OF QUANTITIES

Name of Work: Development of Garden adjacent to Godown No:31 and 32 at NMP					
Ite m No.	DESCRIPTION OF ITEM	QTY	UNIT	RATE IN figures	AMOUNT (Rs. Ps.)
1	Supply of JCB for leveling and clearing the debries/ soil including cost and conveyance of all materials, labours, driver, tools etc., complete.	4.00	Ope	12,420.00	49,680.00
2	Supply of tipper to load and dump the unwanted materials as directed by the Engineer with in 5KM lead, including cost and conveyance of all materials, labours, driver, tools etc., complete.	4.00	day	16,495.60	65,982.40
3	Providing and Fixing the G.I pipe of dia 40mm of length 2.00m founded in M15 grade cement concrete (45cmx45cmx45cm), 0.6 metre below ground level, including cost and conveyance of all labour, materials etc., complete as per the direction of Engineer.	157.00	Nos	1514.51	2,37,778.07
4	Providing and fixing of shade net green in colour made of 100% virgin HDPE, with light weight messed Polyethylene fabric. Including G.I wire in 4 rows, cost and conveyance of all materials, labours, transportation, fixing etc, complete. as directed by the department.	715.00	Sqmt	213.26	1,52,480.90
5	Supply of red earth of approved quality from the approved quarry including loading and unloading, cost of labour, T&P and all other incidental charges etc. complete as directed by the dept.	290.00	Cum	690.28	2,00,181.20

6	Supply and planting of Royal Palm including earth work excavation, Manuring, soil filling, cost and conveyance of all materials, labours etc., complete.	46.00	Nos	500.00	23,000.00
7	Supply and planting of Eugenia Red plant at 0.30m c/c including earth work excavation, manuring, watering, cost and conveyance of all materials, labours etc., complete.	1204.0 0	Nos	90.00	1,08,360.00
8	Supply and planting of Saflora plant at 0.30m c/c including earth work excavation, manuring, watering, cost and conveyance of all materials, labours etc., complete.	1690.0 0	Nos	85.00	1,43,650.00
9	Supply and laying the PVC pipe of 20cm dia for sprinkling system including fixtures and sprinkler at 5m intervals, cost and conveyance of all materials, labour etc., complete.	230.00	Rm	128.61	29,580.30
Total Rs.					10,10,692.87
Excess / Less (In percentage in two decimals)					
Quoted amount in Figures Rs.					

(Quoted amount - Rupees

Note:

- 1) During the Defect Liability period the contractor has to maintain the Garden with watering/Manuring/Cutting Hedges for One year with required two labours.
- 2) GST as applicable will be paid separately in the Tax invoice.
- 3) Contractor shall file the applicable returns with Tax department in time and submit the same as documentary evidence.

SIGNATURE OF THE BIDDER

(iii) FORM OF TENDER

NAME OF CONTRACT.....

To
The Chairman
New Mangalore Port Trust
Panambur
Mangalore - 575 010

Sir,

1. We have examined the Conditions of Contract, Specification, Drawings, Bill of Quantities, and Addenda Nos----- for the execution of the above-named Works, and we the undersigned, offer to execute and complete such Works and remedy any defects therein in conformity with the Conditions of Contract, Specifications, Drawings and Bill of Quantities and Addenda
2. We acknowledge that the Appendix forms part of our Tender.
3. We undertake, if our Tender is accepted, to commence the Works as soon as is reasonably possible after the receipt of the Engineer's notice to commence, and to complete the whole of the Works comprised in the Contract within the time stated in the Appendix to Tender.
4. We agree to abide by this Tender for the period of 90 days from the last date fixed for receiving the same and it shall remain binding upon us and may be accepted at any time before the expiration of that period.
5. Unless and until a formal Agreement is prepared and executed, this Tender together with your written acceptance thereof shall constitute a binding Contract between us.

6. We understand that you are not bound to accept the lowest or any tender you may receive.

Dated this _____ day of _____ 201____
Signature _____ in the Capacity of _____
duly
authorised to sign Tenders for and on behalf of _____

(IN BLOCK

LETTERS)

Address: _____

Witnesses

1. Signature : _____
Name : _____
Address : _____

2. Signature : _____
Name : _____
Address : _____

SECTION VII**SCHEDULE - A****ROYALTY****SCHEDULE II****(See sub rule (1) of Rule 36)**

SI. No.	Name of the Mineral	Present Rate of Royalty	Royalty to be revised	
			Export	Domestic
1	Ornamental and Decorative Building Stones as defined under clause(m) of Rule 2 A)Dyke Rock (i)Black granites: (a)Chamarajanagar District:	15% of Sale Value or of Average Selling Price on advalorembasis or Rs.4,500 per m ³ which is higher.	Rs.1,200 per MT	Rs.600 per MT
	(b)All other Districts other than(a)above	15% of Sale Value or of Average Selling Price on advalorem basis orRs.1,500 per m ³ which is higher.	Rs.1700 per MT	Rs.400 per MT
	(ii)Other varieties of dyke other than black granites(Entire State)	15% of Sale Value or of Average Selling Price on advulorembasis or Rs.1,500per m ³ which is higher.	Rs.500 per MT	Rs.375 per MT
	(B)(l)Pink and Red Granites (Ilkal Pink Variety) (i) Hungunda and BadamiTaluk of Bagalkot District, Kustagi of Koppal District.	15%of Sale Value or of Average Selling Price on advalorembasis or Rs.1,200	Rs.1,000 per MT	Rs.400per rMT
	(ii) Pink and Red Granites, Gneissess and their structural verities (other than Ilkal Pink Variety)	15% of Sale Value or Average Selling Price on advalorem basis or Rs.1,800 Variety) per m ³	Rs.600 per MT	Rs.350 per MT

		which is higher		
	C) Grey and White Granites and their varieties: (i) Very fine grained Grey granite (Siragrey Variety) Price on Chintanmi, Siddlaghatta of Chikkaballapura District Hoskote of Bangalore District.	15% of Sale Value or of Average Selling Price on advalorem basis or Rs.1,350 per m ³ which is higher.	Rs.500 per MT	Rs.350 per MT
	(ii) Grey and white granites and textural varieties having shades of grey, black and white colours (other than (i) above Entire State.	15% of Sale Value or of Average Selling Price on advalorem basis or Rs.1,050 per m ³ which is higher.	Rs.375 per MT	Rs.250 per MT
	(iii) Grey granite of Devanahalli Taluk of Bangalore Rural District and Chikkaballapur Taluk of Chikkaballapur District	15% of Sale Value or of Average Selling Price on advalorem basis or Rs.600 per m ³ which is higher.	Rs.300 per MT	Rs.200 per MT
2	Felsite and its varieties suitable for use as Ornamental Stone-Entire State	15% of Sale Value or of Average Selling Price on advalorem basis or Rs.1800 per m ³ which is higher.	Rs.900 per MT	
3	Quartzite and sand stone and their varieties suitable for use as Ornamental Stone-Entire State	15% of Sale Value or of Average Selling Price on advalorem basis or Rs.1800 per m ³ which is higher.	Rs.900 per MT	
4	Marble and Crystalline Limestone as ornamental Stone-Entire State	15% of Sale Value or of Average Selling Price on advalorem basis or Rs.1800 per m ³ which is higher.	Rs.1000 per MT	
5	Bentonite-Entire State	Rs.400 per MT	Rs.500 per MT	
6	Fuller Earth-Entire State	Rs.125 per MT	Rs.125 per MT	

7	Buff colour (waste) the permits not exceed 20% of permit issued For Fullers Earth	Rs.60 per MT	Rs.70 per MT
8	Limestone under the title "Shahabad Stone"	Rs.70 per 10 Sqmeters or Rs.70 per MT	Rs.50 per 10 Sqmeters or Rs.50 per MT
9	Limestone(non-cement) when used for building stone-Entire State	Rs.25 per MT	Rs.60 per MT
10	Ordinary Building Stone(Entire State as defined under clause(g) of Rule2(1))	Rs.60 per MT	Rs.70 per MT
11	Limeshell-Entire State	100 per MT	120 per MT
12	Lime Kankar(non cement) Entire State	50 per MT	80 per MT
13	Agate, Chalcedony, Flint-Entire State	240 per MT	300 per MT
14	Ordinary Sand-Entire State	60 Per MT	80 Per MT
15	Steatite and sand stone used for making household utensils / articles-Entire State.	40 Per MT	80 Per MT
16	(i)Murrum (All types of soils)-Entire State	20 per MT	40 per MT
	(ii)Clay used for manufacturing tile sand bricks	40 per MT	60 per MT
17	Waste rocks generated in ornamental stone quarry-which is suitable for ornamental purpose Entire State (See explanation under Rule36)	300 per MT or 850 CUM	300perMT
18	Irregular shaped waste rock generated in Ornamental stone quarry, which is not suitable for ornamental purpose (used for making aggregates and m-sand) Entire State.	60 per MT	40 per MT
19	Waste rocks generated in Shahabad stone quarry-Entire State (See explanation under Rule-36)	60 per MT	40 per MT

20	Finished Kerb stones/cubes not exceeding 30 cms each face-Entire State.	110per MT	150 per MT
21	Barytes (i) A Grade (Grey colour) (ii) B Grade (Greycolour) (iii) C, D Grade &Waste	6.5% of average selling price or of sale value whichever is higher on ad-valorem basis	400 per MT 300 per MT 200 per MT
22	Calcite	15% of average selling price or of sale value whichever is higher on ad-valorem basis	80 per MT
23	China clay and Kaolin (including Ball clay, White shell, Fireclay and white clay) i)Crude/Raw ii)Processed	8% of average selling price or of sale value whichever is higher on ad-valorem basis. 12% of average selling price or of sale value whichever is higher on ad-valorem basis	80 Per MT 600 per MT
24	Corundum	12% of average selling price or of sale value whichever is higher on ad-valorem basis	15% of Sale Value or of Average Selling Price on ad valorem basis which is higher.
25	Dolomite	Rs.75 per MT	100 per MT
26	Dunite and Pyroxenite	Rs. 30 per MT	60 per MT
27	Felsite (Other than for ornamental purpose)	12% of average selling price or of sale value whichever is higher on ad-valorem basis	120 per MT
28	Gypsum	20% of average selling price or of sale value whichever is higher on ad-valorem basis	150 per MT
29	Jasper	12% of average selling price or of sale value whichever is higher on ad-valorem	150 per MT

		basis	
30	Quartz, feldspar	15% of average selling price or of sale value whichever is higher on ad-valorem basis	100 per MT
31	Mica i. Crude ii. Waste	4% of average selling price or of sale value whichever is higher on ad-valorem basis	1500 per MT 500 per MT
32	Quartzite & Fuchsite Quartzite not suitable for use as Ornamental /Gemstones	12% of average selling price or of sale value whichever is higher on ad-valorem basis	100 per MT
33	Laterite i) /dispatched for use in cement or chemical industries or Abrasive or Refractory purpose (below threshold value as specified by IBM from time to time) ii) For use as building stone (below threshold value as specified by IBM)	Rs.60 per MT	160 per MT 60 per MT
34	Ochre	Rs.24 per MT	60 per MT
35	Pyrophyllite	20% of average selling price or of sale value whichever is higher on ad-valorem basis	200 per MT
36	Shale	Rs.60 per MT	150 per MT
37	Slate	Rs.45 per MT	150 per MT
38	Silica Sand	10% of average selling price or of sale value whichever is higher on ad-valorem basis	100 per MT

39	Steatite or Soapstone (Other than for house hold articles)	18% of average selling price or of sale value whichever is higher on ad-valorem basis	200perMT
	Talc	--	200perMT
40	All other minerals (which is not specified in schedule-II) Entire State	30% of sale value on ad-valorem basis	30% of Sale Value or of Average Selling Price on ad- valorem basis which is higher.

As per order of Deputy Director mines and Geological department dated 11-11-2021. The prevailing rates as per the updated order of the Geological Department during the course of the project will be applicable.

Note: Except where otherwise stated, the contractor shall pay to the authority all tonnage and other royalties, rent and other payments or compensation if any, for getting stone, sand, gravel, clay or other materials by him and his subordinates and his subcontractors and required for the works, at the rates and such conditions as notified by the State Government. The contractor should submit the Mineral Dispatch Permit (MDP) in original for the quantity executed by the contractor for the requisite quantity of material incorporated in works for which MDP is issued by the authorized supplier. If contractor fails to submit the MDP in original the amount will be deducted at 5 times the royalty charges from the contractor's bills as per prevailing orders issued by the Authority.

____\$\$****\$\$____

SECTION VII**SCHEDULE – B****MINIMUM RATES OF WAGES****ABSTRACT OF MINIMUM RATES OF WAGES FROM RELEVANT NOTIFICATIONS**

MINIMUM RATES OF WAGES APPLICABLE IN THE BEAT OF ALC(C), MANGALORE WITH EFFECT FROM **01.10.2024**

Minimum Wages applicable “Construction or maintenance of roads, runways or in building operations including laying down underground electric, wireless, radio, television, telephone and overseas communication cables and similar other underground cabling work, electric lines, water supply lines and sewerage pipelines”-

Category	Area: A	Area: B	Area: C
Unskilled	783.00	655.00	526.00
Semiskilled/ Unskilled Supervisory	868.00	739.00	614.00
Skilled/Clerical	954.00	868.00	739.00
Highly Skilled	1035.00	954.00	868.00

(Kindly Note: Area A: Bangalore (UA), Area B: Mangalore (UA), Mysore (UA), Belgaum (UA), Hubli-Dharwad, Area C: All other places in Karnataka not specified above as per Ministry of Labour and Employment F.No. 1 /27(3)/2023-LS-II dated 25.09.2024.)

“Employment of Sweeping and Cleaning excluding activities prohibited under the Employment of Manual Scavengers and Construction of Dry latrines (Prohibition) Act, 1933”.

Area	Rates of wages Rs.
‘A’	783.00
‘B’	655.00
‘C’	526.00

“Employment of Watch and Ward”-Rates of wages for employees employed in watch and ward – Govt. of India, Ministry of Labour

	Without arms	With arms
Area	Rates of wages Rs.	Rates of wages Rs.
‘A’	954.00	1035.00
‘B’	868.00	954.00
‘C’	739.00	868.00

For further details log on to Ministry of Employment